

# FOLDING HAND TROLLEY



**HILLVER Folding Hand Trolley** Collection is designed to deliver practical solutions for modern transport and handling needs. Combining easy folding design, durable material construction, strong load capacity, and compact storage size, every product offers reliability, convenience, and efficient performance for professional, commercial, and everyday use across various applications and working environments.



# CONTENT

<b>MULTIFUNCTIONAL TABLE DOLLY</b> .....	<b>1</b>
HTD-01 .....	2
<b>MULTIFUNCTION HAND TRUCK</b> .....	<b>4</b>
HMHT-90TP .....	5
<b>FOLDING DOLLY &amp; CART</b> .....	<b>7</b>
HFDC-99HA .....	8
HFDC-99H .....	10
<b>SHOPPING CART</b> .....	<b>12</b>
HSC-90SE .....	13
<b>FOLDING HAND TRUCK</b> .....	<b>15</b>
HFHT-90SF .....	16
HFHT-90S .....	17
HFHT-90MS .....	18
HFHT-90E .....	19
HFHT-90M .....	20
HFHT-90L .....	21
HFHT-90S6 .....	22
HFHT-90N6 .....	23
HFHT-90SN .....	24
HFHT-90SNA .....	25
HFHT-90SNA6 .....	26
HFHT-90STA6 .....	27
HFHT-90STH .....	28
HFHT-92 .....	29
HFHT-92CT .....	30
HFHT-92V .....	31
HFHT-90C .....	32
HFHT-90BHL .....	33
<b>PLATFORM HAND TRUCK</b> .....	<b>34</b>
HPHT-99FS .....	35
HPHT-99F .....	37
HPHT-99FBC .....	38
HPHT-99PS .....	39
HPHT-99PL .....	40
HPHT-99B .....	41
HPHT-99C .....	42
HPHT-99D .....	43

# CONTENT

HPHT-99E .....	44
HPHT-99CAC .....	45
<b>FOLDING BASKET .....</b>	<b>46</b>
HFB-003 .....	46
HFB-002 .....	47
HFB-99G .....	48
HFB-001 .....	50
<b>ALUMINUM HAND TROLLEY .....</b>	<b>51</b>
HAHT-85 .....	52
HAHT-86 .....	54
HAHT-80 .....	55
HAHT-80A .....	56
HAHT-81 .....	57
HAHT-81B .....	58
HAHT-82 .....	59
HAHT-82B .....	60
HAHT-82C .....	61
HAHT-82A .....	62
HAHT-82NB .....	63
HAHT-83 .....	65
HAHT-83A .....	66
HAHT-83B .....	67
HAHT-83C .....	68
HAHT-83D .....	69
HAHT-83E .....	70
HAHT-84 .....	71
HAHT-84E .....	72
HAHT-84A .....	73
HAHT-84B .....	74
HAHT-806 .....	75
HAHT-84F .....	76
HAHT-88A .....	77
HAHT-88F .....	78
HLC-70B .....	79
HLC-71 .....	80
HLC-72 .....	81
<b>HARDWARE ACCESSORIES .....</b>	<b>82</b>

# Hillver

THE RIGHT EQUIPMENT FOR EVERY TASK



FOLDING HAND TROLLEY

# MULTIFUNCTIONAL TABLE DOLLY

Easy Folding Design

Strong Load Capacity

Durable material Build

Compact Storage Size

The Multifunctional Table Dolly is a versatile solution designed for convenience and efficiency. It easily transforms between a table, dolly, and platform truck, supporting various tasks. Built with durable materials and a foldable structure, it ensures strong load capacity, easy storage, and reliable performance for both indoor and outdoor use.

# MULTIFUNCTIONAL TABLE DOLLY

## TYPE HTD-01

The Multifunctional Table Dolly is a versatile solution designed for convenience and efficiency. It easily transforms between a table, dolly, and platform truck, supporting various tasks. Built with durable materials and a foldable structure, it ensures strong load capacity, easy storage, and reliable performance for both indoor and outdoor use.



EASY FOLDING DESIGN



STRONG LOAD CAPACITY



DURABLE MATERIAL BUILD



COMPACT STORAGE SIZE

### SPECIFICATION

ITEM NO.	HTD-01
NET WEIGHT	10.4kg
OVERALL SIZE	Table: 573 x 858 x 500/600mm   Dolly: 573 x 858 x 252mm Platform truck: 573 x 858 x 884mm
FOLDABLES SIZE	573 x 858 x 85 mm
CAPACITY	Table: 100kg Truck: 150kg
WHEELS	5.5 inch
MATERIALS	Alum, PP, TPR

# MULTIFUNCTIONAL TABLE DOLLY

TYPE **HTD-01**

Folded



Table



Platform Truck



Dolly



With Basket



Extending With Cover HTD-01



With Clip-on Light



Adjust Heights in Legs



Optional Holder



Hole for Umbrella



**Hilver**  
THE RIGHT EQUIPMENT FOR EVERY TASK



● FOLDING HAND TROLLEY ●

# MULTIFUNCTIONAL HAND TRUCK

Easy Folding Design

Strong Load Capacity

Durable material Build

Compact Storage Size

The Multifunctional Hand Truck is engineered for flexibility and performance across various transport needs. It can be used in both vertical and horizontal positions, adapting to different loads. Featuring a foldable design, durable construction, and smooth mobility, it offers strong capacity, compact storage, and reliable handling for everyday professional and personal use.

# MULTIFUNCTIONAL HAND TRUCK

## TYPE HMHT-90TP

The Multifunctional Hand Truck is engineered for flexibility and performance across various transport needs. It can be used in both vertical and horizontal positions, adapting to different loads. Featuring a foldable design, durable construction, and smooth mobility, it offers strong capacity, compact storage, and reliable handling for everyday professional and personal use.



EASY FOLDING  
DESIGN



STRONG LOAD  
CAPACITY



DURABLE  
MATERIAL BUILD



COMPACT  
STORAGE SIZE



## SPECIFICATION

ITEM NO.	HMHT-90TP
NET WEIGHT	7.3kg
OVERALL SIZE	458 x 777 x 684/800/920mm   458 x 416 x 1100/1220/1340mm
FOLDABLES SIZE	389 x 117 x 643 mm
BASE PLATE	350 x 280 mm
WHEELS	3.5/5 inch
MATERIALS	Alum, PP, TPR, Iron

# MULTIFUNCTIONAL HAND TRUCK

TYPE **HMHT-90TP**

Folding

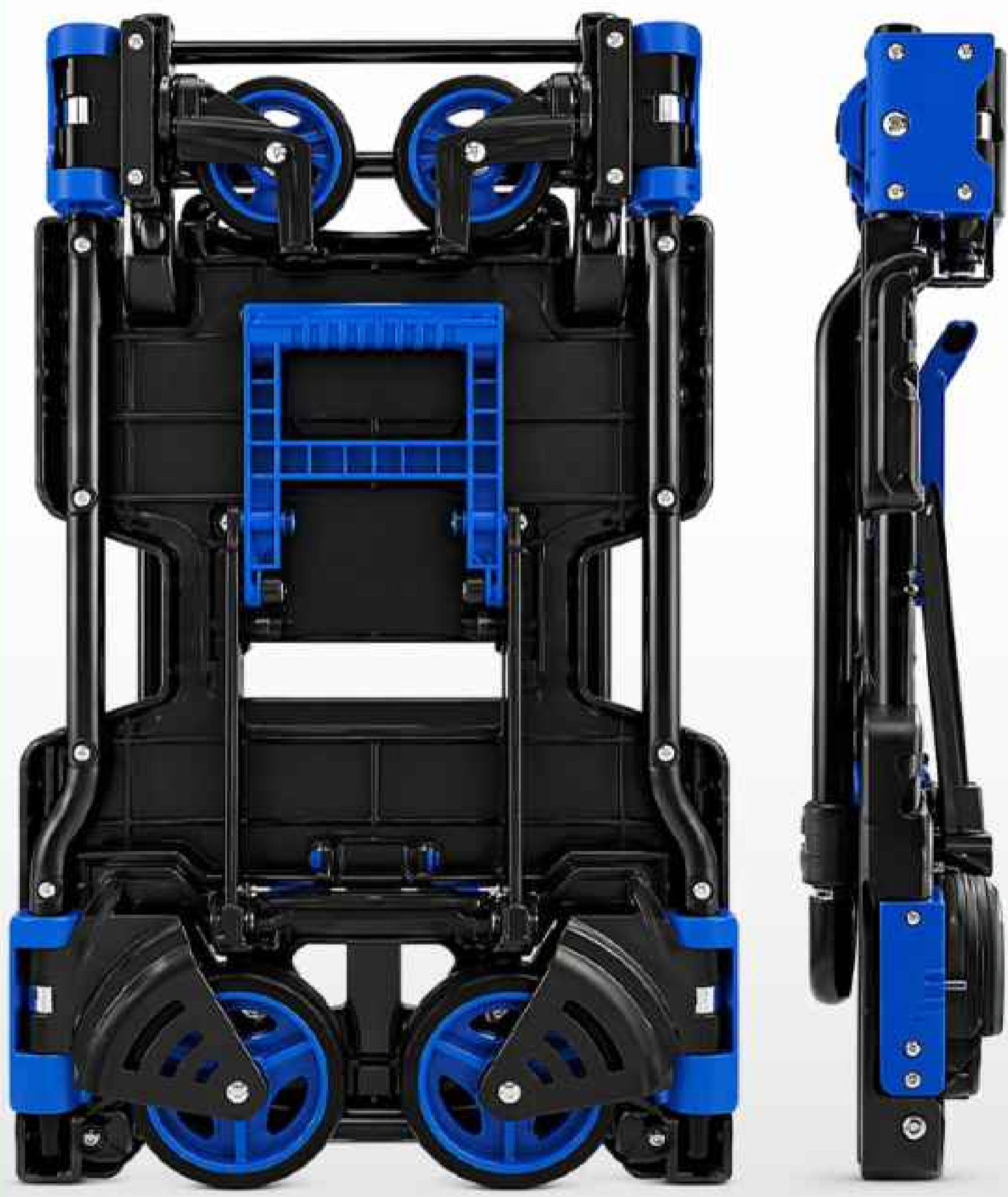

Horizontal



Vertical

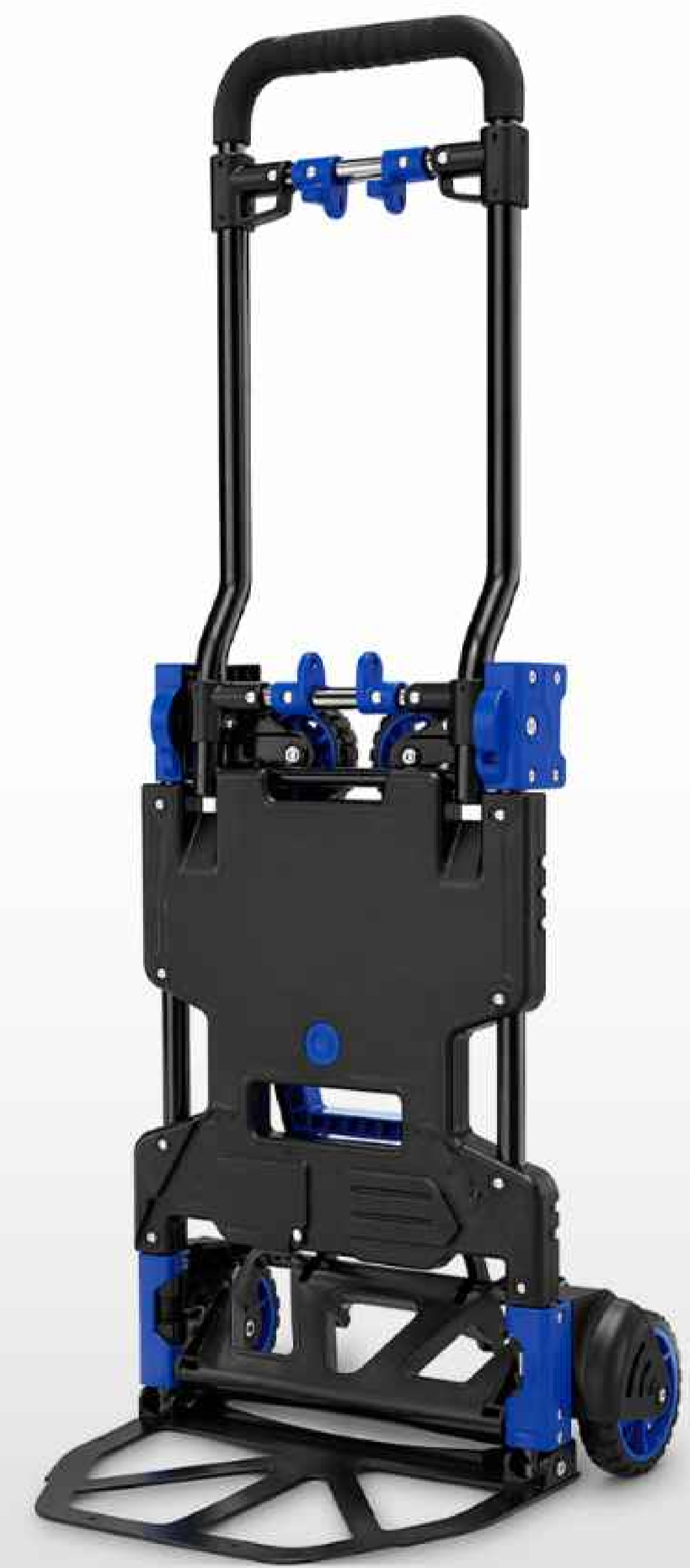

Fold Flat For Transport\_Storage



Horizontal Position



Vertical Position



# Hillver

THE RIGHT EQUIPMENT FOR EVERY TASK



FOLDING HAND TROLLEY

# FOLDING DOLLY & CART

Easy Folding Design

Strong Load Capacity

Durable material Build

Compact Storage Size

The Folding Dolly & Cart is designed for efficient transport and easy storage. Its foldable structure allows quick setup and compact storage when not in use. Built with durable materials and stable wheels, it provides reliable load support, smooth mobility, and versatile functionality for handling goods in various working and daily environments.

# FOLDING DOLLY & CART

## TYPE HFDC-99HA

The Folding Dolly & Cart is designed for efficient transport and easy storage. Its foldable structure allows quick setup and compact storage when not in use. Built with durable materials and stable wheels, it provides reliable load support, smooth mobility, and versatile functionality for handling goods in various working and daily environments.



EASY FOLDING DESIGN



STRONG LOAD CAPACITY



DURABLE MATERIAL BUILD



COMPACT STORAGE SIZE

## SPECIFICATION

ITEM NO.	HFDC-99HA
NET WEIGHT	5.4kg
OVERALL SIZE	620 x 450 x 730 mm
FOLDABLES SIZE	620 x 450 x 77 mm
WHEELS	3 inch
MATERIALS	Alum, PR, TPR

# FOLDING DOLLY & CART

TYPE **HFDC-99HA**

Use as Dolly



Press the Button to Unlock & Open the Handle



With Basket



Single Pack & PDQ Display Box Pack



# FOLDING DOLLY & CART

## TYPE HFDC-99H

The Folding Dolly & Cart is designed for efficient transport and easy storage. Its foldable structure allows quick setup and compact storage when not in use. Built with durable materials and stable wheels, it provides reliable load support, smooth mobility, and versatile functionality for handling goods in various working and daily environments.



EASY FOLDING DESIGN



STRONG LOAD CAPACITY



DURABLE MATERIAL BUILD



COMPACT STORAGE SIZE

## SPECIFICATION

ITEM NO.	HFDC-99H
NET WEIGHT	4.8kg
OVERALL SIZE	600 x 450 x 167 mm
FOLDABLES SIZE	600 x 450 x 77 mm
WHEELS	3 inch
MATERIALS	Alum, PR, TPR

# FOLDING DOLLY & CART

TYPE **HFDC-99H**

Use as Dolly



HFDC-99HA Splicing With HFDC-99H



**HOW TO SPLICE**

Align the panels and lock the splice securely.



Press the Button to Unlock & Open the Handle



With Basket



Single Pack & PDQ Display Box Pack



**Hillver**  
THE RIGHT EQUIPMENT FOR EVERY TASK



● FOLDING HAND TROLLEY ●

# SHOPPING CART

Easy Folding Design

Strong Load Capacity

Durable material Build

Compact Storage Size

The Shopping Cart is designed to make carrying items easier and more efficient. With a lightweight yet durable frame, it ensures smooth mobility and reliable performance. Its foldable design allows compact storage, while the spacious capacity accommodates daily needs, making it ideal for shopping, travel, and everyday transport convenience.

# SHOPPING CART

## TYPE HSC-90SE

The Shopping Cart is designed to make carrying items easier and more efficient. With a lightweight yet durable frame, it ensures smooth mobility and reliable performance. Its foldable design allows compact storage, while the spacious capacity accommodates daily needs, making it ideal for shopping, travel, and everyday transport convenience.



EASY FOLDING DESIGN



STRONG LOAD CAPACITY



DURABLE MATERIAL BUILD



COMPACT STORAGE SIZE



## SPECIFICATION

ITEM NO.	HSC-90SE
NET WEIGHT	3.2 kg
OVERALL SIZE	357 x 410 x 1000 mm
FOLDABLES SIZE	357 x 92 x 586 mm
BASE PLATE	390 x 280 mm
WHEELS	5 inch
MATERIALS	Alum, PP, TPR

# SHOPPING CART

TYPE **HSC-90SE**

Take Out The Bungee Cord



Put The Foot On The Pedal, and Push Forward Gently



With Shopping Bag



Off-ground Plate Keeping Wet and Dirt Away



# Hillver

THE RIGHT EQUIPMENT FOR EVERY TASK



FOLDING HAND TROLLEY

# FOLDING HAND TRUCK

Easy Folding Design

Strong Load Capacity

Durable material Build

Compact Storage Size

The Folding Hand Truck is built for convenient transport and space-saving storage. Its foldable design allows quick deployment and compact storage after use. Constructed with durable materials, it ensures strong load capacity and stability. Equipped with smooth wheels and an ergonomic handle, it delivers reliable performance for various handling tasks.

# FOLDING HAND TRUCK

## TYPE HFHT-90SF

The Folding Hand Truck is built for convenient transport and space-saving storage. Its foldable design allows quick deployment and compact storage after use. Constructed with durable materials, it ensures strong load capacity and stability. Equipped with smooth wheels and an ergonomic handle, it delivers reliable performance for various handling tasks.



EASY FOLDING DESIGN



STRONG LOAD CAPACITY



DURABLE MATERIAL BUILD



COMPACT STORAGE SIZE

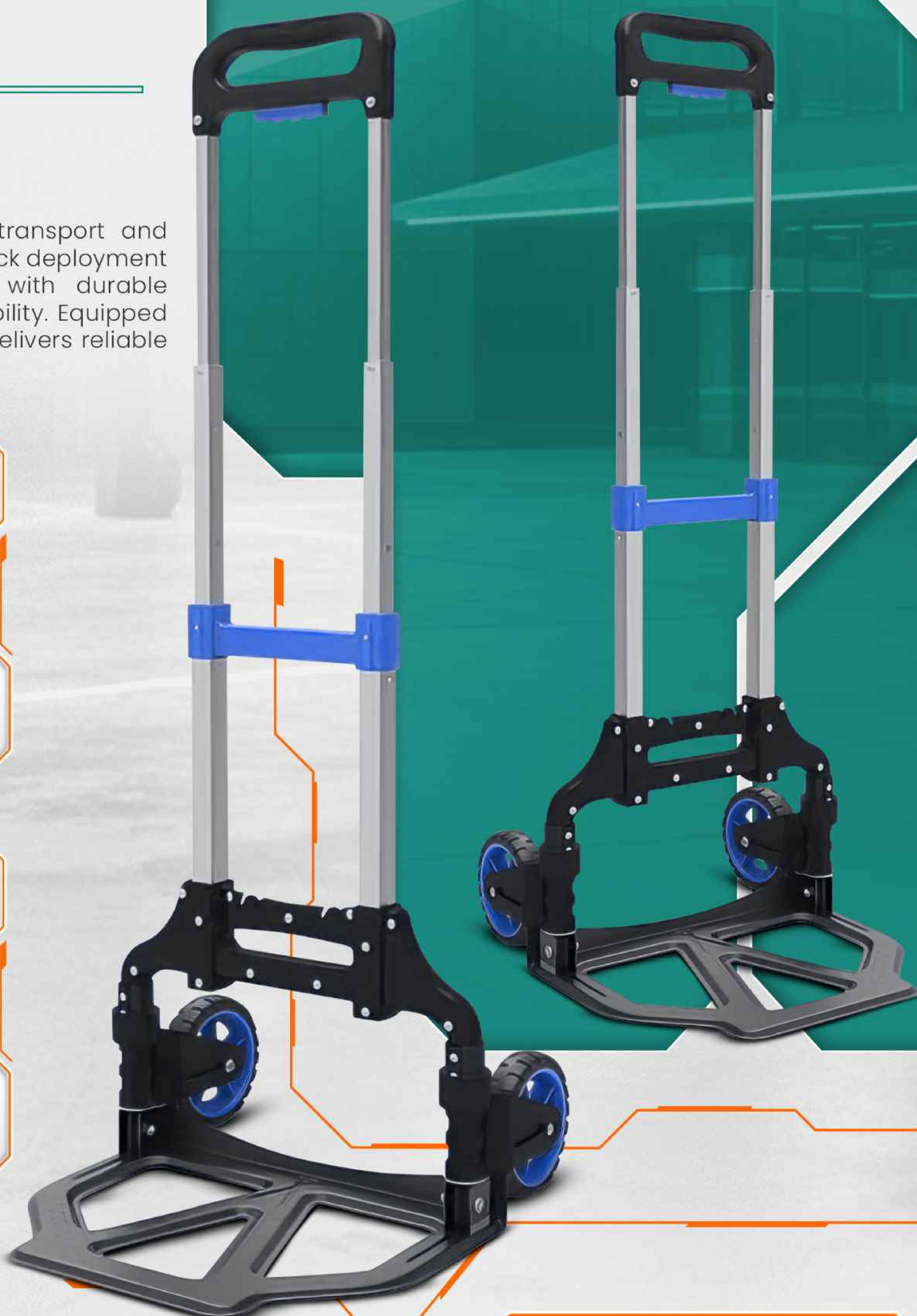

## SPECIFICATION

ITEM NO.	HFHT-90SF
NET WEIGHT	3.6 kg
OVERALL SIZE	400 x 417 x 1000 mm
FOLDABLES SIZE	385 x 57 x 630 mm
BASE PLATE	388 x 288 mm
WHEELS	5 inch
MATERIALS	Alum, PP, TPR

# FOLDING HAND TRUCK

## TYPE HFHT-90S

The Folding Hand Truck is built for convenient transport and space-saving storage. Its foldable design allows quick deployment and compact storage after use. Constructed with durable materials, it ensures strong load capacity and stability. Equipped with smooth wheels and an ergonomic handle, it delivers reliable performance for various handling tasks.



EASY FOLDING DESIGN



STRONG LOAD CAPACITY



DURABLE MATERIAL BUILD



COMPACT STORAGE SIZE



## SPECIFICATION

ITEM NO.	HFHT-90S
NET WEIGHT	3.04 kg
OVERALL SIZE	400 x 400 x 900/1000 mm
FOLDABLES SIZE	385 x 55 x 635 mm
BASE PLATE	390 x 280 mm
WHEELS	5 inch
MATERIALS	Alum, PP, TPR

# FOLDING HAND TRUCK

## TYPE HFHT-90MS

The Folding Hand Truck is built for convenient transport and space-saving storage. Its foldable design allows quick deployment and compact storage after use. Constructed with durable materials, it ensures strong load capacity and stability. Equipped with smooth wheels and an ergonomic handle, it delivers reliable performance for various handling tasks.



EASY FOLDING DESIGN



STRONG LOAD CAPACITY



DURABLE MATERIAL BUILD



COMPACT STORAGE SIZE



## SPECIFICATION

ITEM NO.	HFHT-90MS
NET WEIGHT	3.55 kg
OVERALL SIZE	400 x 41 x 1000 mm
FOLDABLES SIZE	390 x 600 x 710 mm
BASE PLATE	390 x 280 mm
WHEELS	5 inch
MATERIALS	Alum, PP, TPR

# FOLDING HAND TRUCK

## TYPE HFHT-90E

The Folding Hand Truck is built for convenient transport and space-saving storage. Its foldable design allows quick deployment and compact storage after use. Constructed with durable materials, it ensures strong load capacity and stability. Equipped with smooth wheels and an ergonomic handle, it delivers reliable performance for various handling tasks.



EASY FOLDING DESIGN



STRONG LOAD CAPACITY



DURABLE MATERIAL BUILD



COMPACT STORAGE SIZE



## SPECIFICATION

ITEM NO.	HFHT-90E
NET WEIGHT	4.6 kg
OVERALL SIZE	500 x 450 x 1080 mm
FOLDABLES SIZE	490 x 60 x 810 mm
BASE PLATE	485 x 285 mm
WHEELS	7 inch
MATERIALS	Alum, PP, TPR

# FOLDING HAND TRUCK

## TYPE HFHT-90M

The Folding Hand Truck is built for convenient transport and space-saving storage. Its foldable design allows quick deployment and compact storage after use. Constructed with durable materials, it ensures strong load capacity and stability. Equipped with smooth wheels and an ergonomic handle, it delivers reliable performance for various handling tasks.



EASY FOLDING DESIGN



STRONG LOAD CAPACITY



DURABLE MATERIAL BUILD



COMPACT STORAGE SIZE



## SPECIFICATION

ITEM NO.	HFHT-90M
NET WEIGHT	6.8 kg
OVERALL SIZE	500 x 520 x 1070 mm
FOLDABLES SIZE	490 x 65 x 770 mm
BASE PLATE	480 x 360 mm
WHEELS	7 inch
MATERIALS	Alum, PP, TPR

# FOLDING HAND TRUCK

## TYPE HFHT-90L

The Folding Hand Truck is built for convenient transport and space-saving storage. Its foldable design allows quick deployment and compact storage after use. Constructed with durable materials, it ensures strong load capacity and stability. Equipped with smooth wheels and an ergonomic handle, it delivers reliable performance for various handling tasks.



EASY FOLDING DESIGN



STRONG LOAD CAPACITY



DURABLE MATERIAL BUILD



COMPACT STORAGE SIZE



## SPECIFICATION

ITEM NO.	HFHT-90L
NET WEIGHT	9.7 kg
OVERALL SIZE	595 x 600 x 1280 mm
FOLDABLES SIZE	595 x 100 x 1020 mm
BASE PLATE	590 x 400 mm
WHEELS	8 inch
MATERIALS	Alum, PP, TPR

# FOLDING HAND TRUCK

## TYPE HFHT-90S6

The Folding Hand Truck is built for convenient transport and space-saving storage. Its foldable design allows quick deployment and compact storage after use. Constructed with durable materials, it ensures strong load capacity and stability. Equipped with smooth wheels and an ergonomic handle, it delivers reliable performance for various handling tasks.



EASY FOLDING DESIGN



STRONG LOAD CAPACITY



DURABLE MATERIAL BUILD



COMPACT STORAGE SIZE



## SPECIFICATION

ITEM NO.	HFHT-90S6
NET WEIGHT	3.16 kg
OVERALL SIZE	414 x 414 x 1004 mm
FOLDABLES SIZE	393 x 67 x 632 mm
BASE PLATE	390 x 280 mm
WHEELS	2.3 inch
MATERIALS	Alum, PP, TPR

# FOLDING HAND TRUCK

## TYPE HFHT-90N6

The Folding Hand Truck is built for convenient transport and space-saving storage. Its foldable design allows quick deployment and compact storage after use. Constructed with durable materials, it ensures strong load capacity and stability. Equipped with smooth wheels and an ergonomic handle, it delivers reliable performance for various handling tasks.



EASY FOLDING DESIGN



STRONG LOAD CAPACITY



DURABLE MATERIAL BUILD



COMPACT STORAGE SIZE

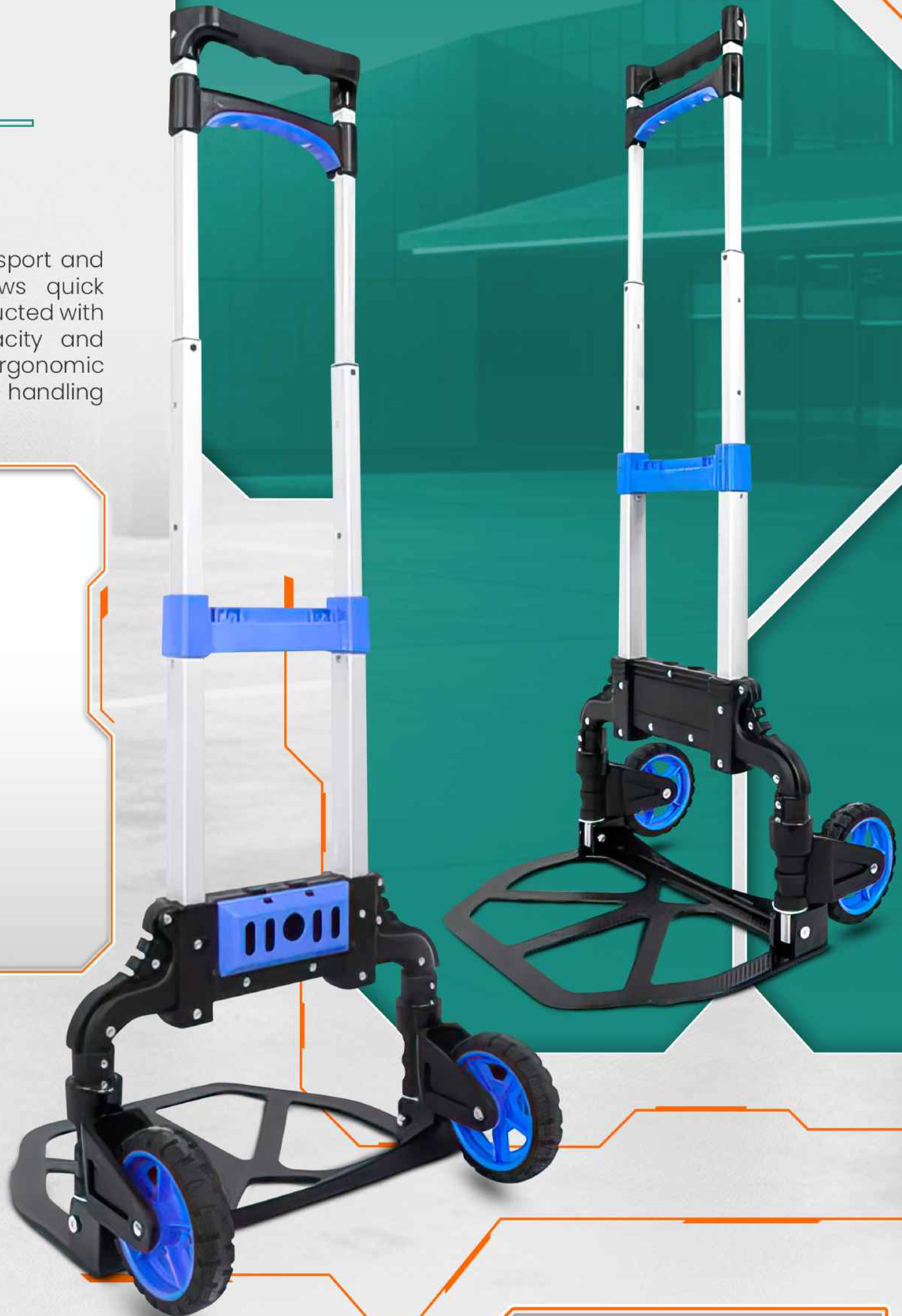

## SPECIFICATION

ITEM NO.	HFHT-90N6
NET WEIGHT	3.27 kg
OVERALL SIZE	413 x 414 x 1004 mm
FOLDABLES SIZE	393 x 67 x 632 mm
BASE PLATE	390 x 280 mm
WHEELS	2.3 inch
MATERIALS	Alum, PP, TPR

# FOLDING HAND TRUCK

## TYPE HFHT-90SN

The Folding Hand Truck is built for convenient transport and space-saving storage. Its foldable design allows quick deployment and compact storage after use. Constructed with durable materials, it ensures strong load capacity and stability. Equipped with smooth wheels and an ergonomic handle, it delivers reliable performance for various handling tasks.



EASY FOLDING DESIGN



STRONG LOAD CAPACITY



DURABLE MATERIAL BUILD



COMPACT STORAGE SIZE



## SPECIFICATION

ITEM NO.	HFHT-90SN
NET WEIGHT	3.08 kg
OVERALL SIZE	400 x 410 x 1000 mm
FOLDABLES SIZE	390 x 55 x 635 mm
BASE PLATE	390 x 280 mm
WHEELS	5 inch
MATERIALS	Alum, PP, TPR

# FOLDING HAND TRUCK

## TYPE HFHT-90SNA

The Folding Hand Truck is built for convenient transport and space-saving storage. Its foldable design allows quick deployment and compact storage after use. Constructed with durable materials, it ensures strong load capacity and stability. Equipped with smooth wheels and an ergonomic handle, it delivers reliable performance for various handling tasks.



EASY FOLDING DESIGN



STRONG LOAD CAPACITY



DURABLE MATERIAL BUILD



COMPACT STORAGE SIZE



## SPECIFICATION

ITEM NO.	HFHT-90SNA
NET WEIGHT	3.3 kg
OVERALL SIZE	400 x 410 x 1004 mm
FOLDABLES SIZE	390 x 65 x 635 mm
BASE PLATE	390 x 280 mm
WHEELS	5 inch
MATERIALS	Alum, PP, TPR

# FOLDING HAND TRUCK

## TYPE HFHT-90SNA6

The Folding Hand Truck is built for convenient transport and space-saving storage. Its foldable design allows quick deployment and compact storage after use. Constructed with durable materials, it ensures strong load capacity and stability. Equipped with smooth wheels and an ergonomic handle, it delivers reliable performance for various handling tasks.



EASY FOLDING DESIGN



STRONG LOAD CAPACITY



DURABLE MATERIAL BUILD



COMPACT STORAGE SIZE

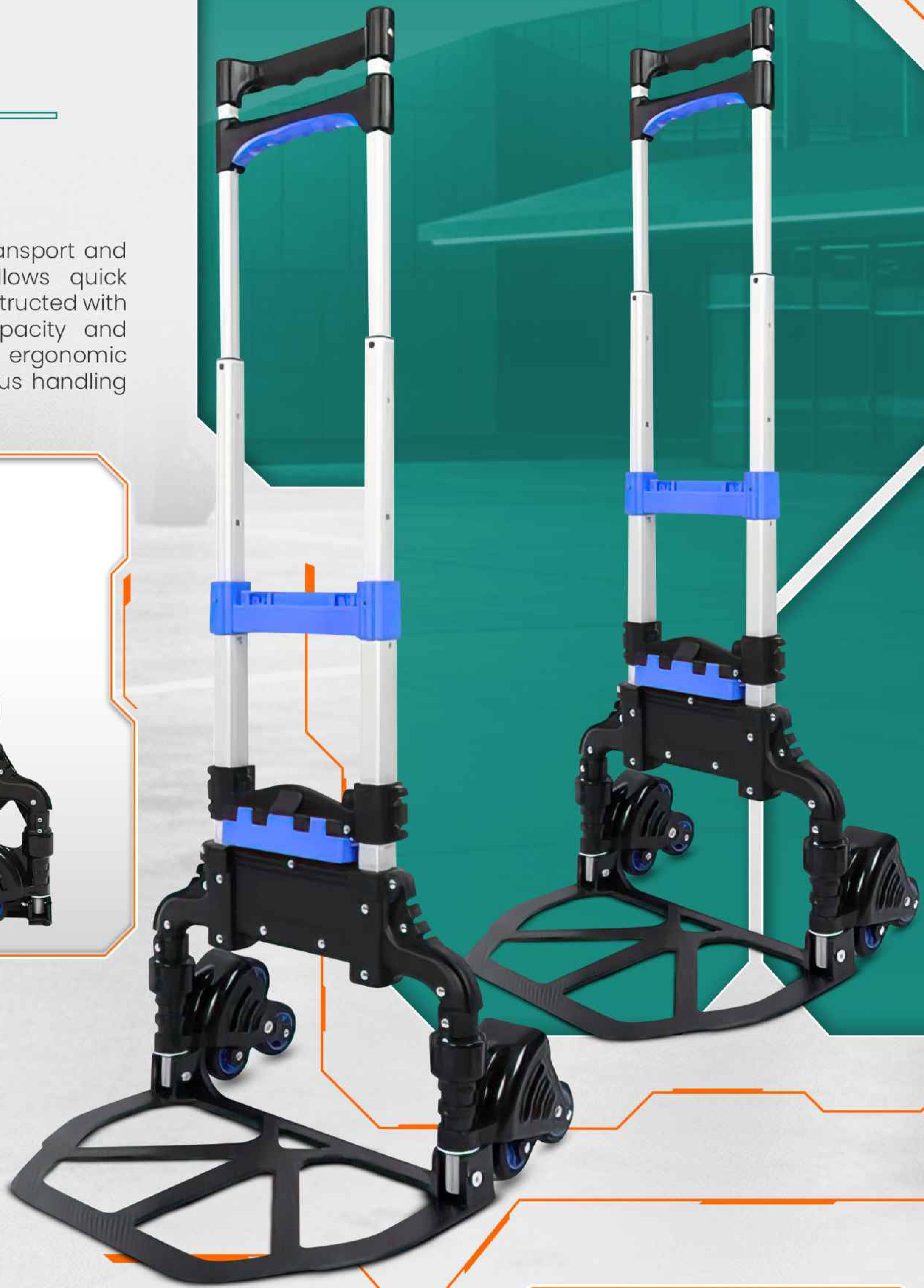

## SPECIFICATION

ITEM NO.	HFHT-90SNA6
NET WEIGHT	3.33 kg
OVERALL SIZE	413 x 414 x 1004 mm
FOLDABLES SIZE	390 x 67 x 635 mm
BASE PLATE	390 x 280 mm
WHEELS	2.3 inch
MATERIALS	Alum, PP, TPR

# FOLDING HAND TRUCK

## TYPE HFHT-90STA6

The Folding Hand Truck is built for convenient transport and space-saving storage. Its foldable design allows quick deployment and compact storage after use. Constructed with durable materials, it ensures strong load capacity and stability. Equipped with smooth wheels and an ergonomic handle, it delivers reliable performance for various handling tasks.



EASY FOLDING DESIGN



STRONG LOAD CAPACITY



DURABLE MATERIAL BUILD



COMPACT STORAGE SIZE

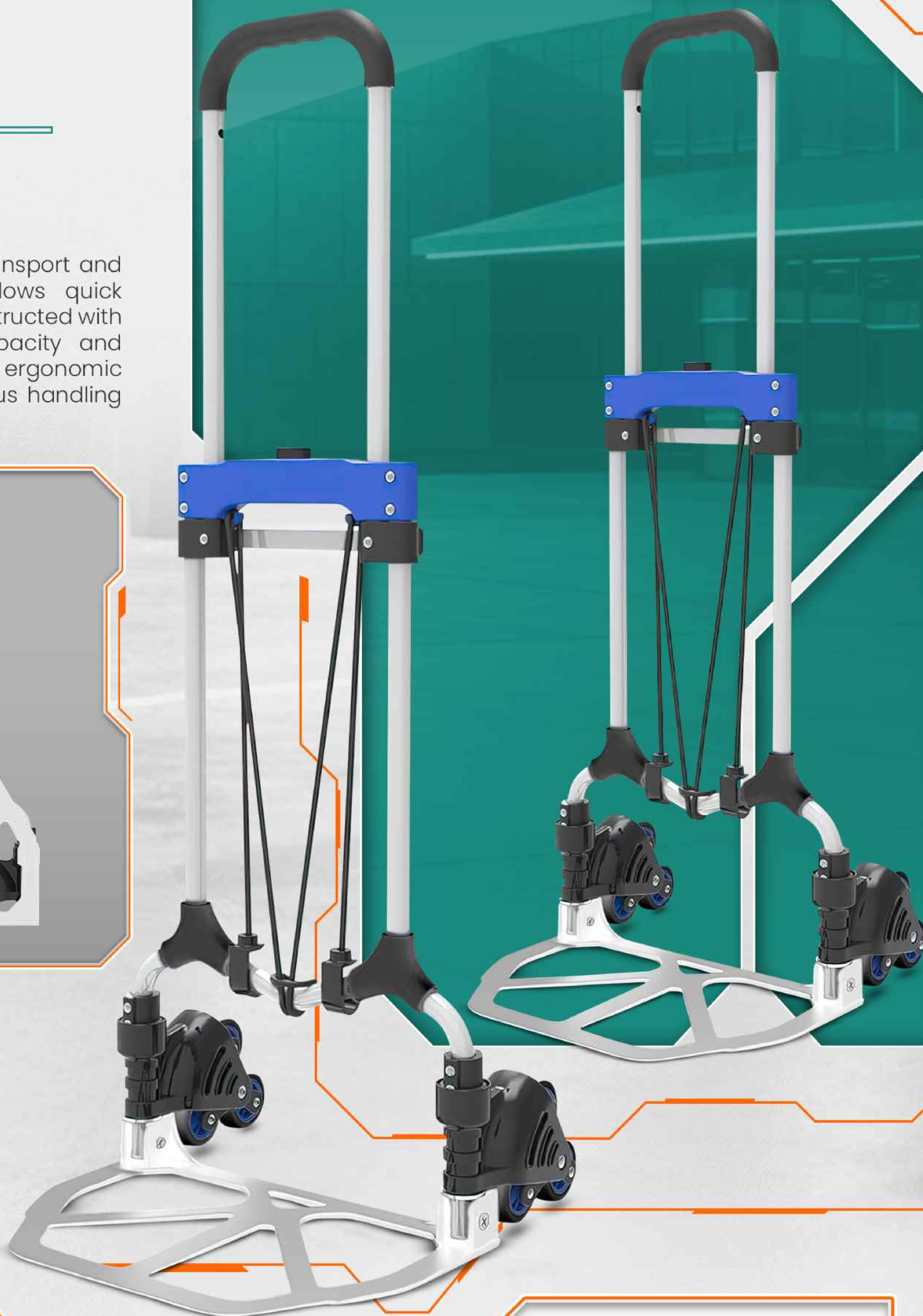
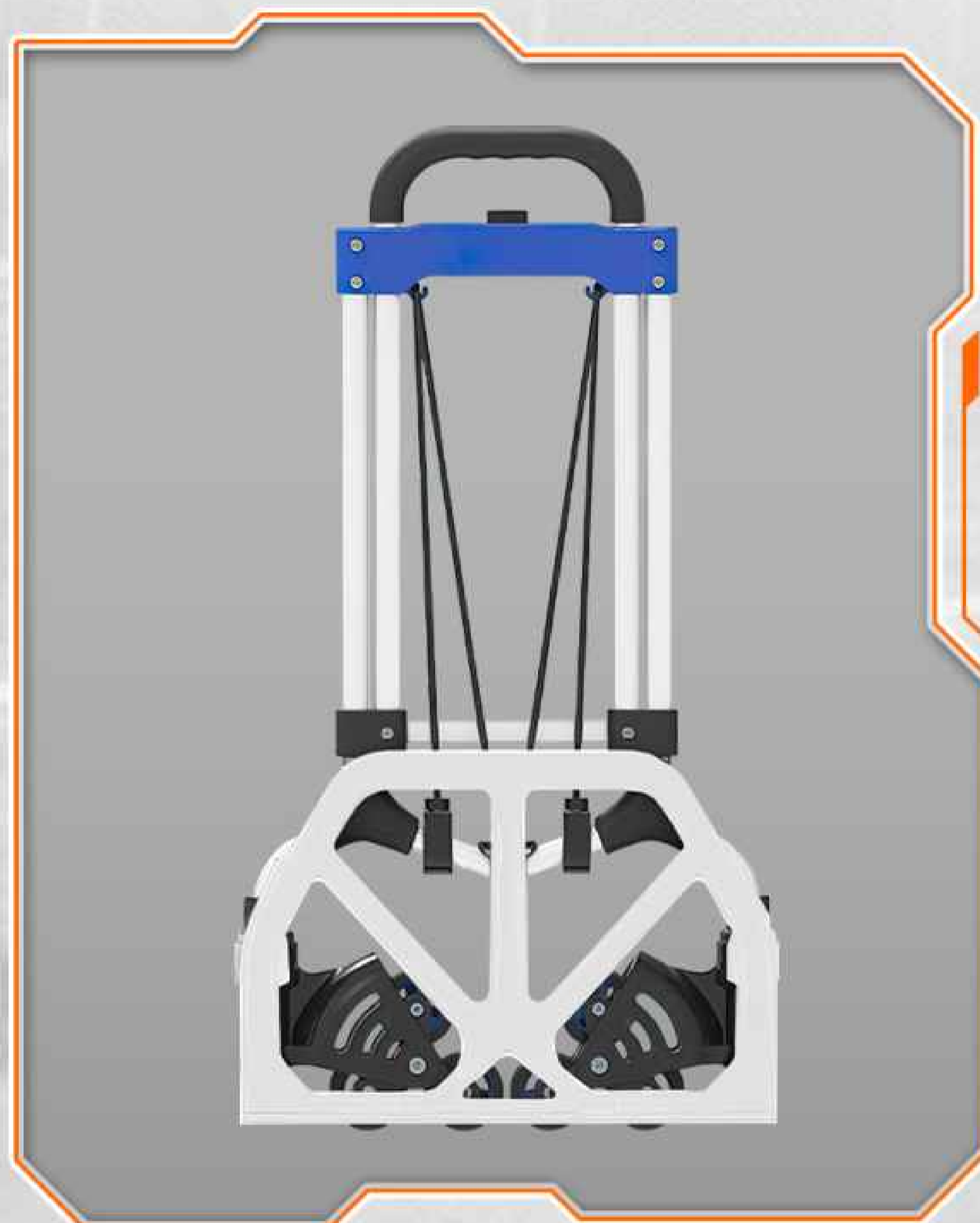

## SPECIFICATION

ITEM NO.	HFHT-90STA6
NET WEIGHT	3.9 kg
OVERALL SIZE	416 x 417 x 1036 mm
FOLDABLES SIZE	396 x 70 x 732 mm
BASE PLATE	388 x 268 mm
WHEELS	2.3 inch
MATERIALS	Iron, Alum, PP, TPR

# FOLDING HAND TRUCK

## TYPE HFHT-90STH

The Folding Hand Truck is built for convenient transport and space-saving storage. Its foldable design allows quick deployment and compact storage after use. Constructed with durable materials, it ensures strong load capacity and stability. Equipped with smooth wheels and an ergonomic handle, it delivers reliable performance for various handling tasks.



EASY FOLDING DESIGN



STRONG LOAD CAPACITY



DURABLE MATERIAL BUILD



COMPACT STORAGE SIZE



## SPECIFICATION

ITEM NO.	HFHT-90STH
NET WEIGHT	3.76 kg
OVERALL SIZE	400 x 420 x 1020 mm
FOLDABLES SIZE	390 x 57 x 730 mm
BASE PLATE	390 x 280 mm
WHEELS	5 inch
MATERIALS	Iron, Alum, PP, TPR

# FOLDING HAND TRUCK

## TYPE HFHT-92

The Folding Hand Truck is built for convenient transport and space-saving storage. Its foldable design allows quick deployment and compact storage after use. Constructed with durable materials, it ensures strong load capacity and stability. Equipped with smooth wheels and an ergonomic handle, it delivers reliable performance for various handling tasks.



EASY FOLDING DESIGN



STRONG LOAD CAPACITY



DURABLE MATERIAL BUILD



COMPACT STORAGE SIZE

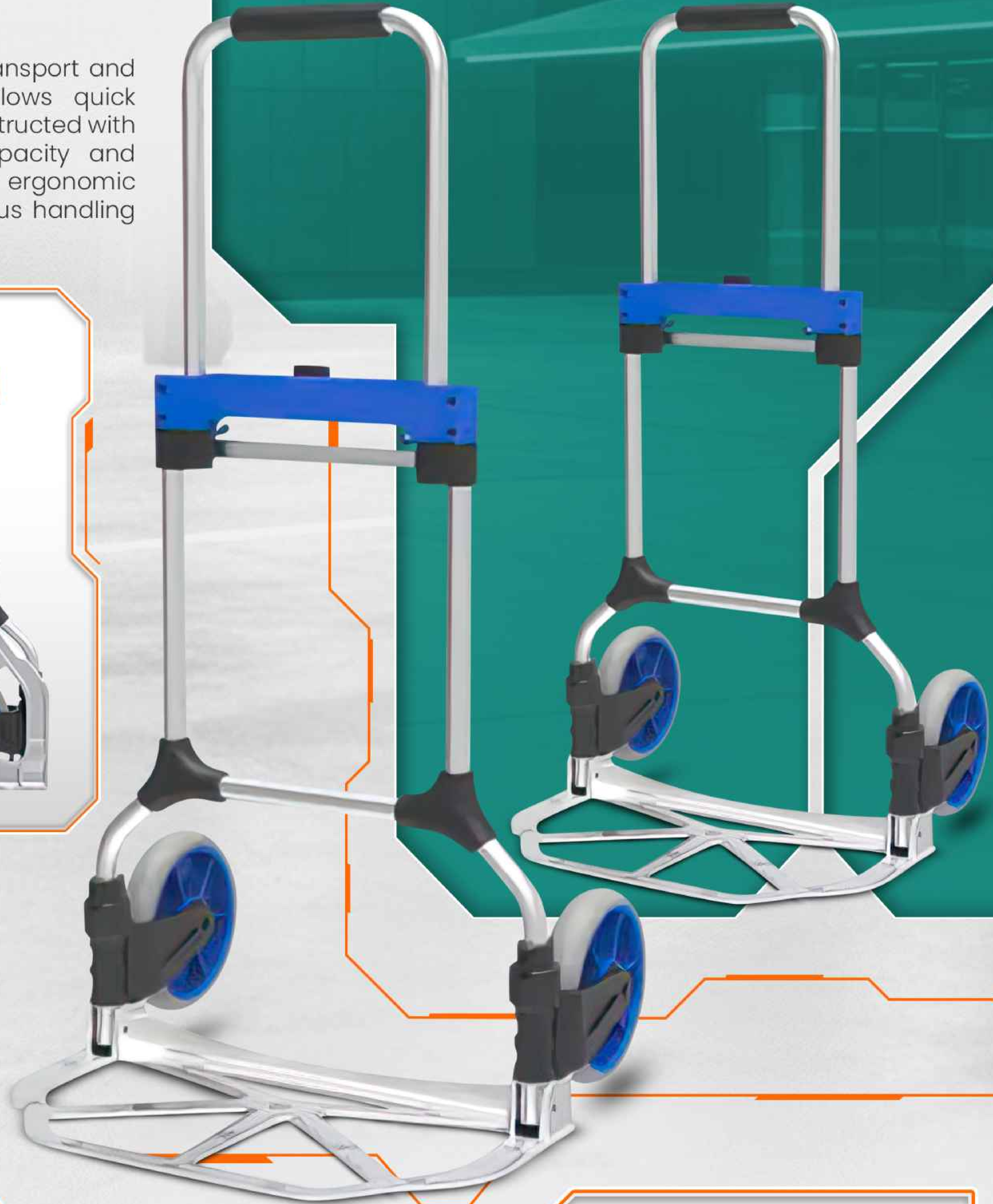

## SPECIFICATION

ITEM NO.	HFHT-92
NET WEIGHT	4.38 kg
OVERALL SIZE	495 x 451.8 x 960 mm
FOLDABLES SIZE	486 x 61 x 720 mm
BASE PLATE	485 x 285 mm
WHEELS	7 inch
MATERIALS	Alum, PP, TPR

# FOLDING HAND TRUCK

## TYPE HFHT-92CT

The Folding Hand Truck is built for convenient transport and space-saving storage. Its foldable design allows quick deployment and compact storage after use. Constructed with durable materials, it ensures strong load capacity and stability. Equipped with smooth wheels and an ergonomic handle, it delivers reliable performance for various handling tasks.



EASY FOLDING DESIGN



STRONG LOAD CAPACITY



DURABLE MATERIAL BUILD



COMPACT STORAGE SIZE

## SPECIFICATION

ITEM NO.	HFHT-92CT
NET WEIGHT	5 kg
OVERALL SIZE	495 x 452 x 983 mm
FOLDABLES SIZE	500 x 65 x 740 mm
BASE PLATE	485 x 285 mm
WHEELS	7 inch
MATERIALS	Iron, Alum, PP, TPR

# FOLDING HAND TRUCK

## TYPE HFHT-92V

The Folding Hand Truck is built for convenient transport and space-saving storage. Its foldable design allows quick deployment and compact storage after use. Constructed with durable materials, it ensures strong load capacity and stability. Equipped with smooth wheels and an ergonomic handle, it delivers reliable performance for various handling tasks.



EASY FOLDING DESIGN



STRONG LOAD CAPACITY



DURABLE MATERIAL BUILD



COMPACT STORAGE SIZE



## SPECIFICATION

ITEM NO.	HFHT-92V
NET WEIGHT	4.38 kg
OVERALL SIZE	495 x 451 x 983 mm
FOLDABLES SIZE	486 x 61 x 730 mm
BASE PLATE	485 x 285 mm
WHEELS	7 inch
MATERIALS	Alum, PP, TPR

# FOLDING HAND TRUCK

## TYPE HFHT-90C

The Folding Hand Truck is built for convenient transport and space-saving storage. Its foldable design allows quick deployment and compact storage after use. Constructed with durable materials, it ensures strong load capacity and stability. Equipped with smooth wheels and an ergonomic handle, it delivers reliable performance for various handling tasks.



EASY FOLDING DESIGN



STRONG LOAD CAPACITY



DURABLE MATERIAL BUILD



COMPACT STORAGE SIZE



## SPECIFICATION

ITEM NO.	HFHT-90C
NET WEIGHT	5.1 kg
OVERALL SIZE	489 x 522 x 1080 mm
FOLDABLES SIZE	484 x 66 x 820 mm
BASE PLATE	485 x 285 mm
WHEELS	7 inch
MATERIALS	Alum, PP, TPR

# FOLDING HAND TRUCK

## TYPE HFHT-90BHL

The Folding Hand Truck is built for convenient transport and space-saving storage. Its foldable design allows quick deployment and compact storage after use. Constructed with durable materials, it ensures strong load capacity and stability. Equipped with smooth wheels and an ergonomic handle, it delivers reliable performance for various handling tasks.



EASY FOLDING DESIGN



STRONG LOAD CAPACITY



DURABLE MATERIAL BUILD



COMPACT STORAGE SIZE

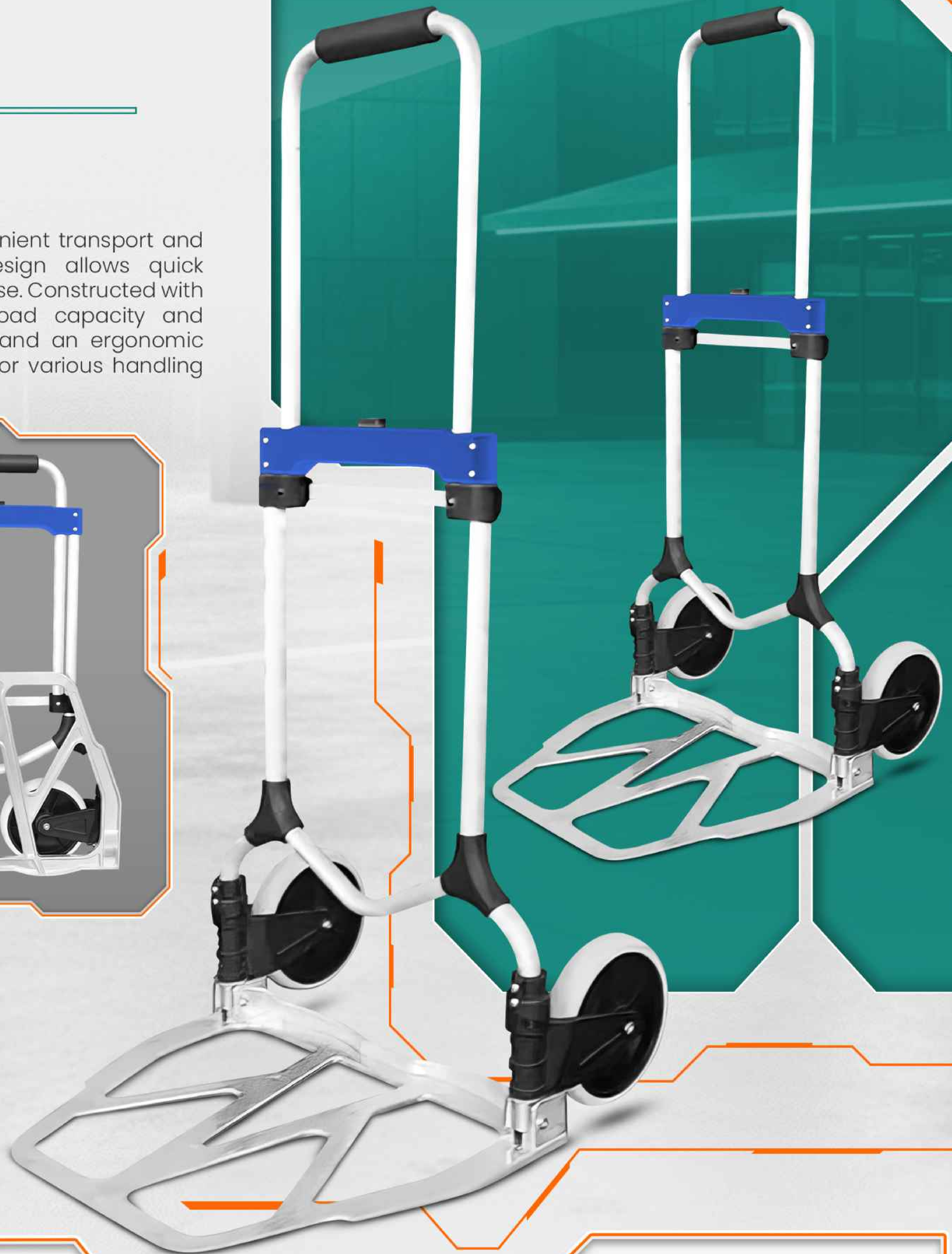

## SPECIFICATION

ITEM NO.	HFHT-90BHL
NET WEIGHT	18.9 kg
OVERALL SIZE	520 x 500 x 1080 mm
FOLDABLES SIZE	500 x 65 x 800 mm
BASE PLATE	410 x 487 mm
WHEELS	7 inch
MATERIALS	Alum, PP, TPR

**Hillver**  
THE RIGHT EQUIPMENT FOR EVERY TASK



● FOLDING HAND TROLLEY ●

# PLATFORM HAND TRUCK

Easy Folding Design

Strong Load Capacity

Durable material Build

Compact Storage Size

The Platform Hand Truck is designed for heavy duty transport with maximum stability and ease of use. Its wide platform supports large loads securely, while durable construction ensures long lasting performance. Equipped with smooth-rolling wheels and a foldable handle, it offers efficient handling, strong capacity, and convenient storage for various industrial and daily applications.

# PLATFORM HAND TRUCK

## TYPE HPHT-99FS

The Platform Hand Truck is designed for heavy-duty transport with maximum stability and ease of use. Its wide platform supports large loads securely, while durable construction ensures long-lasting performance. Equipped with smooth-rolling wheels and a foldable handle, it offers efficient handling, strong capacity, and convenient storage for various industrial and daily applications.



EASY FOLDING  
DESIGN



STRONG LOAD  
CAPACITY



DURABLE  
MATERIAL BUILD



COMPACT  
STORAGE SIZE



## SPECIFICATION

ITEM NO.	HPHT-99FS
NET WEIGHT	5.2 kg
OVERALL SIZE	373 x 614 x 894 mm
FOLDABLES SIZE	373 x 84 x 614 mm
BASE PLATE	373 x 615 mm
WHEELS	3 inch
MATERIALS	Alum, PP, TPR

# PLATFORM HAND TRUCK

TYPE **HPHT-99FS**

HPHT-99FS



One Step Folded



Adjustable Height



With 3 Tailgates



# PLATFORM HAND TRUCK

## TYPE HPHT-99F

The Platform Hand Truck is designed for heavy-duty transport with maximum stability and ease of use. Its wide platform supports large loads securely, while durable construction ensures long-lasting performance. Equipped with smooth-rolling wheels and a foldable handle, it offers efficient handling, strong capacity, and convenient storage for various industrial and daily applications.



EASY FOLDING  
DESIGN



STRONG LOAD  
CAPACITY



DURABLE  
MATERIAL BUILD



COMPACT  
STORAGE SIZE



## SPECIFICATION

ITEM NO.	HPHT-99F
NET WEIGHT	6.4 kg
OVERALL SIZE	675 x 411 x 920 mm
FOLDABLES SIZE	411 x 84 x 675 mm
BASE PLATE	411 x 675 mm
WHEELS	4 inch
MATERIALS	Alum, PP, TPR

# PLATFORM HAND TRUCK

## TYPE HPHT-99FBC

The Platform Hand Truck is designed for heavy-duty transport with maximum stability and ease of use. Its wide platform supports large loads securely, while durable construction ensures long-lasting performance. Equipped with smooth-rolling wheels and a foldable handle, it offers efficient handling, strong capacity, and convenient storage for various industrial and daily applications.



EASY FOLDING  
DESIGN



STRONG LOAD  
CAPACITY



DURABLE  
MATERIAL BUILD



COMPACT  
STORAGE SIZE



## SPECIFICATION

ITEM NO.	HPHT-99FBC
NET WEIGHT	12 kg
OVERALL SIZE	517 x 802 x 873 mm
FOLDABLES SIZE	517 x 802 x 105 mm
BASE PLATE	517 x 802 mm
WHEELS	4 inch
MATERIALS	Alum, PP, TPR

# PLATFORM HAND TRUCK

## TYPE HPHT-99PS

The Platform Hand Truck is designed for heavy-duty transport with maximum stability and ease of use. Its wide platform supports large loads securely, while durable construction ensures long-lasting performance. Equipped with smooth-rolling wheels and a foldable handle, it offers efficient handling, strong capacity, and convenient storage for various industrial and daily applications.



EASY FOLDING  
DESIGN



STRONG LOAD  
CAPACITY



DURABLE  
MATERIAL BUILD



COMPACT  
STORAGE SIZE



## SPECIFICATION

ITEM NO.	HPHT-99PS
NET WEIGHT	9.24 kg
OVERALL SIZE	468 x 740 x 925 mm
FOLDABLES SIZE	740 x 468 x 274 mm
BASE PLATE	468 x 740 mm
WHEELS	4 inch
MATERIALS	Alum, PP, TPR

# PLATFORM HAND TRUCK

## TYPE HPHT-99PL

The Platform Hand Truck is designed for heavy-duty transport with maximum stability and ease of use. Its wide platform supports large loads securely, while durable construction ensures long-lasting performance. Equipped with smooth-rolling wheels and a foldable handle, it offers efficient handling, strong capacity, and convenient storage for various industrial and daily applications.



EASY FOLDING  
DESIGN



STRONG LOAD  
CAPACITY



DURABLE  
MATERIAL BUILD



COMPACT  
STORAGE SIZE



## SPECIFICATION

ITEM NO.	HPHT-99PL
NET WEIGHT	13 kg
OVERALL SIZE	610 x 900 x 945 mm
FOLDABLES SIZE	900 x 610 x 286 mm
BASE PLATE	610 x 900 mm
WHEELS	5 inch
MATERIALS	Iron, PP, TPR

# PLATFORM HAND TRUCK

## TYPE HPHT-99B

The Platform Hand Truck is designed for heavy-duty transport with maximum stability and ease of use. Its wide platform supports large loads securely, while durable construction ensures long-lasting performance. Equipped with smooth-rolling wheels and a foldable handle, it offers efficient handling, strong capacity, and convenient storage for various industrial and daily applications.



EASY FOLDING  
DESIGN



STRONG LOAD  
CAPACITY



DURABLE  
MATERIAL BUILD



COMPACT  
STORAGE SIZE

## SPECIFICATION

ITEM NO.	HPHT-99B
NET WEIGHT	12 kg
OVERALL SIZE	900 x 620 x 960 mm
PLATFORM	900 x 620 mm
WHEELS	5 inch
MATERIALS	Iron, Alum, TPR

# PLATFORM HAND TRUCK

## TYPE HPHT-99C

The Platform Hand Truck is designed for heavy-duty transport with maximum stability and ease of use. Its wide platform supports large loads securely, while durable construction ensures long-lasting performance. Equipped with smooth-rolling wheels and a foldable handle, it offers efficient handling, strong capacity, and convenient storage for various industrial and daily applications.



EASY FOLDING  
DESIGN



STRONG LOAD  
CAPACITY



DURABLE  
MATERIAL BUILD



COMPACT  
STORAGE SIZE

## SPECIFICATION

ITEM NO.	HPHT-99C
NET WEIGHT	10 kg
OVERALL SIZE	740 x 480 x 900 mm
PLATFORM	740 x 480 mm
WHEELS	4 inch
MATERIALS	Iron, Alum, TPR

# PLATFORM HAND TRUCK

## TYPE HPHT-99D

The Platform Hand Truck is designed for heavy-duty transport with maximum stability and ease of use. Its wide platform supports large loads securely, while durable construction ensures long-lasting performance. Equipped with smooth-rolling wheels and a foldable handle, it offers efficient handling, strong capacity, and convenient storage for various industrial and daily applications.



EASY FOLDING  
DESIGN



STRONG LOAD  
CAPACITY



DURABLE  
MATERIAL BUILD



COMPACT  
STORAGE SIZE



## SPECIFICATION

ITEM NO.	HPHT-99D
NET WEIGHT	18.6 kg
OVERALL SIZE	900 x 600 x 960 mm
PLATFORM	900 x 600 mm
WHEELS	7 inch
MATERIALS	Iron, Alum, TPR

# PLATFORM HAND TRUCK

## TYPE HPHT-99E

The Platform Hand Truck is designed for heavy-duty transport with maximum stability and ease of use. Its wide platform supports large loads securely, while durable construction ensures long-lasting performance. Equipped with smooth-rolling wheels and a foldable handle, it offers efficient handling, strong capacity, and convenient storage for various industrial and daily applications.



EASY FOLDING  
DESIGN



STRONG LOAD  
CAPACITY



DURABLE  
MATERIAL BUILD



COMPACT  
STORAGE SIZE

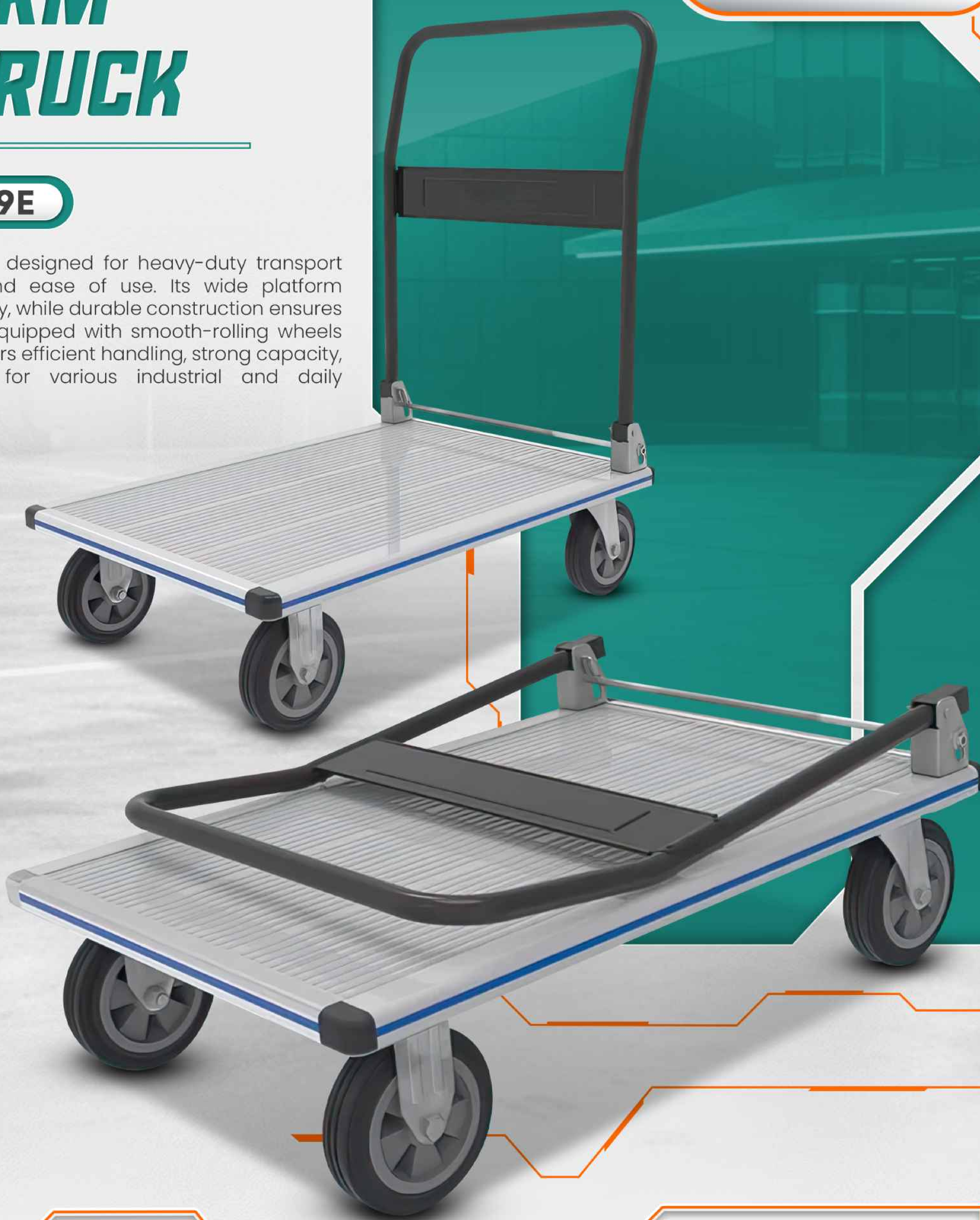

## SPECIFICATION

ITEM NO.	HPHT-99E
NET WEIGHT	17.14 kg
OVERALL SIZE	900 x 610 x 1010 mm
PLATFORM	610 x 900 mm
WHEELS	7 inch
MATERIALS	Iron, Alum, TPR

# PLATFORM HAND TRUCK

## TYPE HPHT-99CAC

The Platform Hand Truck is designed for heavy-duty transport with maximum stability and ease of use. Its wide platform supports large loads securely, while durable construction ensures long-lasting performance. Equipped with smooth-rolling wheels and a foldable handle, it offers efficient handling, strong capacity, and convenient storage for various industrial and daily applications.



EASY FOLDING  
DESIGN



STRONG LOAD  
CAPACITY



DURABLE  
MATERIAL BUILD



COMPACT  
STORAGE SIZE

## SPECIFICATION

ITEM NO.	HPHT-99CAC
NET WEIGHT	18.8 kg
OVERALL SIZE	940 x 475 x 1500 mm
PLATFORM	475 x 1500 mm
WHEELS	5 inch
MATERIALS	Iron, Alum, TPR

# Hillver

THE RIGHT EQUIPMENT FOR EVERY TASK



● FOLDING HAND TROLLEY ●

# FOLDING BASKET

Easy Folding Design

Strong Load Capacity

Durable material Build

Compact Storage Size

The Folding Basket is a practical solution for organized storage and easy transport. Its collapsible design allows quick folding for space-saving storage when not in use. Made from durable materials, it provides reliable strength and stability. Lightweight and portable, it is ideal for shopping, carrying goods, and everyday storage needs.

# FOLDING BASKET

## TYPE HFB-003

The Folding Basket is a practical solution for organized storage and easy transport. Its collapsible design allows quick folding for space-saving storage when not in use. Made from durable materials, it provides reliable strength and stability. Lightweight and portable, it is ideal for shopping, carrying goods, and everyday storage needs.



-  EASY FOLDING DESIGN
-  DURABLE MATERIAL BUILD
-  STRONG LOAD CAPACITY
-  COMPACT STORAGE SIZE

## SPECIFICATION

ITEM NO.	HFB-003
NET WEIGHT	2.66 kg
OVERALL SIZE	569 x 410 x 348 mm
FOLDABLE SIZE	569 x 410 x 348 mm
MATERIALS	PP, ABS

# FOLDING BASKET

## TYPE HFB-002

The Folding Basket is a practical solution for organized storage and easy transport. Its collapsible design allows quick folding for space-saving storage when not in use. Made from durable materials, it provides reliable strength and stability. Lightweight and portable, it is ideal for shopping, carrying goods, and everyday storage needs.



EASY FOLDING DESIGN



STRONG LOAD CAPACITY



DURABLE MATERIAL BUILD



COMPACT STORAGE SIZE

## SPECIFICATION

ITEM NO.	HFB-002
NET WEIGHT	1.8 kg
OVERALL SIZE	568.5 x 410 x 272.5 mm
FOLDABLE SIZE	410 x 568 x 75 mm
MATERIALS	PP

# FOLDING BASKET

## TYPE HFB-99G

The Folding Basket is a practical solution for organized storage and easy transport. Its collapsible design allows quick folding for space-saving storage when not in use. Made from durable materials, it provides reliable strength and stability. Lightweight and portable, it is ideal for shopping, carrying goods, and everyday storage needs.



EASY FOLDING DESIGN



STRONG LOAD CAPACITY



DURABLE MATERIAL BUILD



COMPACT STORAGE SIZE



## SPECIFICATION

ITEM NO.	HFB-99G
NET WEIGHT	10 kg
OVERALL SIZE	603 x 990 x 1088 mm
FOLDABLE SIZE	540 x 153 x 736 mm
BASE PLATE	Top platform: 622 x 441 mm Bottom platform: 644 x 535 mm
WHEELS	3.5/7 Inch
MATERIALS	PP

# FOLDING BASKET

TYPE **HFB-99G**



Supporting



Brake



Supporting



# FOLDING BASKET

## TYPE HFB-001

The Folding Basket is a practical solution for organized storage and easy transport. Its collapsible design allows quick folding for space-saving storage when not in use. Made from durable materials, it provides reliable strength and stability. Lightweight and portable, it is ideal for shopping, carrying goods, and everyday storage needs.



EASY FOLDING DESIGN



STRONG LOAD CAPACITY



DURABLE MATERIAL BUILD



COMPACT STORAGE SIZE

## SPECIFICATION

ITEM NO.	HFB-001
NET WEIGHT	0.94 kg
OVERALL SIZE	408 x 25.5 x 560 mm
FOLDABLE SIZE	408 x 25.5 x 560 mm



## FOLDING HAND TROLLEY

# ALUMINUM HAND TROLLEY

Easy Folding Design

Strong Load Capacity

Durable material Build

Compact Storage Size

The Aluminium Hand Trolley is designed for strength, durability, and lightweight performance. Made from high-quality aluminium, it offers excellent resistance to corrosion while maintaining strong load capacity. Its foldable design ensures easy storage, while smooth wheels provide effortless mobility, making it ideal for both professional use and everyday material handling tasks.

# ALUMINUM HAND TROLLEY

## TYPE HAHT-85

The Aluminium Hand Trolley is designed for strength, durability, and lightweight performance. Made from high-quality aluminium, it offers excellent resistance to corrosion while maintaining strong load capacity. Its foldable design ensures easy storage, while smooth wheels provide effortless mobility, making it ideal for both professional use and everyday material handling tasks.



EASY FOLDING DESIGN



STRONG LOAD CAPACITY



DURABLE MATERIAL BUILD



COMPACT STORAGE SIZE



## SPECIFICATION

ITEM NO.	HAHT-85
NET WEIGHT	17 kg
OVERALL SIZE	466 x 506 x 1322 mm 1117 x 506 x 1022 mm
BASE PLATE	457 x 232 x 118.5 mm
WHEELS	5/7 Inch
MATERIALS	Alum

# ALUMINUM HAND TROLLEY

TYPE HAHT-85



Large Pneumatic Wheels For Easy Carry



Strong Handle For Moving heavy Loads



# ALUMINUM HAND TROLLEY

## TYPE HAHT-86

The Aluminium Hand Trolley is designed for strength, durability, and lightweight performance. Made from high-quality aluminium, it offers excellent resistance to corrosion while maintaining strong load capacity. Its foldable design ensures easy storage, while smooth wheels provide effortless mobility, making it ideal for both professional use and everyday material handling tasks.



EASY FOLDING DESIGN



STRONG LOAD CAPACITY



DURABLE MATERIAL BUILD



COMPACT STORAGE SIZE



### SPECIFICATION

ITEM NO.	HAHT-86
NET WEIGHT	19 kg
OVERALL SIZE	466 x 506 x 1561 mm 1447 x 506 x 1139 mm
BASE PLATE	457 x 232 x 118.5 mm
WHEELS	5/10 Inch
MATERIALS	Alum

# ALUMINUM HAND TROLLEY

## TYPE HAHT-80

The Aluminium Hand Trolley is designed for strength, durability, and lightweight performance. Made from high-quality aluminium, it offers excellent resistance to corrosion while maintaining strong load capacity. Its foldable design ensures easy storage, while smooth wheels provide effortless mobility, making it ideal for both professional use and everyday material handling tasks.



EASY FOLDING DESIGN



STRONG LOAD CAPACITY



DURABLE MATERIAL BUILD



COMPACT STORAGE SIZE



### SPECIFICATION

ITEM NO.	HAHT-80
NET WEIGHT	10.5 kg
OVERALL SIZE	467 x 506 x 1606 mm
PLATFORM	355.6 x 232 x 118.5 mm
WHEELS	10 Inch
MATERIALS	Alum

# ALUMINUM HAND TROLLEY

## TYPE HAHT-80A

The Aluminium Hand Trolley is designed for strength, durability, and lightweight performance. Made from high-quality aluminium, it offers excellent resistance to corrosion while maintaining strong load capacity. Its foldable design ensures easy storage, while smooth wheels provide effortless mobility, making it ideal for both professional use and everyday material handling tasks.



EASY FOLDING DESIGN



STRONG LOAD CAPACITY



DURABLE MATERIAL BUILD



COMPACT STORAGE SIZE



## SPECIFICATION

ITEM NO.	HAHT-80A
NET WEIGHT	11.4 kg
OVERALL SIZE	467 x 506 x 1606 mm
PLATFORM	355.6 x 232 x 118.5 mm
WHEELS	10 Inch
MATERIALS	Alum

# ALUMINUM HAND TROLLEY

## TYPE HAHT-81

The Aluminium Hand Trolley is designed for strength, durability, and lightweight performance. Made from high-quality aluminium, it offers excellent resistance to corrosion while maintaining strong load capacity. Its foldable design ensures easy storage, while smooth wheels provide effortless mobility, making it ideal for both professional use and everyday material handling tasks.



EASY FOLDING DESIGN



STRONG LOAD CAPACITY



DURABLE MATERIAL BUILD



COMPACT STORAGE SIZE



## SPECIFICATION

ITEM NO.	HAHT-81
NET WEIGHT	10.5 kg
OVERALL SIZE	467 x 506 x 1538 mm
PLATFORM	355.6 x 232 x 118.5 mm
WHEELS	10 Inch
MATERIALS	Alum

# ALUMINUM HAND TROLLEY

## TYPE HAHT-81B

The Aluminium Hand Trolley is designed for strength, durability, and lightweight performance. Made from high-quality aluminium, it offers excellent resistance to corrosion while maintaining strong load capacity. Its foldable design ensures easy storage, while smooth wheels provide effortless mobility, making it ideal for both professional use and everyday material handling tasks.



EASY FOLDING DESIGN



STRONG LOAD CAPACITY



DURABLE MATERIAL BUILD



COMPACT STORAGE SIZE



## SPECIFICATION

ITEM NO.	HAHT-81B
NET WEIGHT	10.5 kg
OVERALL SIZE	467 x 506 x 1538 mm
PLATFORM	355.6 x 232 x 118.5 mm
WHEELS	10 Inch
MATERIALS	Alum

# ALUMINUM HAND TROLLEY

## TYPE HAHT-82

The Aluminium Hand Trolley is designed for strength, durability, and lightweight performance. Made from high-quality aluminium, it offers excellent resistance to corrosion while maintaining strong load capacity. Its foldable design ensures easy storage, while smooth wheels provide effortless mobility, making it ideal for both professional use and everyday material handling tasks.



EASY FOLDING DESIGN



STRONG LOAD CAPACITY



DURABLE MATERIAL BUILD



COMPACT STORAGE SIZE



## SPECIFICATION

ITEM NO.	HAHT-82
NET WEIGHT	9 kg
OVERALL SIZE	467 x 506 x 1250 mm
PLATFORM	355.6 x 232 x 118.5 mm
WHEELS	10 Inch
MATERIALS	Alum

# ALUMINUM HAND TROLLEY

## TYPE HAHT-82B

The Aluminium Hand Trolley is designed for strength, durability, and lightweight performance. Made from high-quality aluminium, it offers excellent resistance to corrosion while maintaining strong load capacity. Its foldable design ensures easy storage, while smooth wheels provide effortless mobility, making it ideal for both professional use and everyday material handling tasks.



EASY FOLDING DESIGN



STRONG LOAD CAPACITY



DURABLE MATERIAL BUILD



COMPACT STORAGE SIZE



## SPECIFICATION

ITEM NO.	HAHT-82B
NET WEIGHT	10.2 kg
OVERALL SIZE	500 x 506 x 1250 mm
PLATFORM	355.6 x 228.6 x 134 mm
WHEELS	10 Inch
MATERIALS	Alum

# ALUMINUM HAND TROLLEY

## TYPE HAHT-82C

The Aluminium Hand Trolley is designed for strength, durability, and lightweight performance. Made from high-quality aluminium, it offers excellent resistance to corrosion while maintaining strong load capacity. Its foldable design ensures easy storage, while smooth wheels provide effortless mobility, making it ideal for both professional use and everyday material handling tasks.



EASY FOLDING DESIGN



STRONG LOAD CAPACITY



DURABLE MATERIAL BUILD



COMPACT STORAGE SIZE

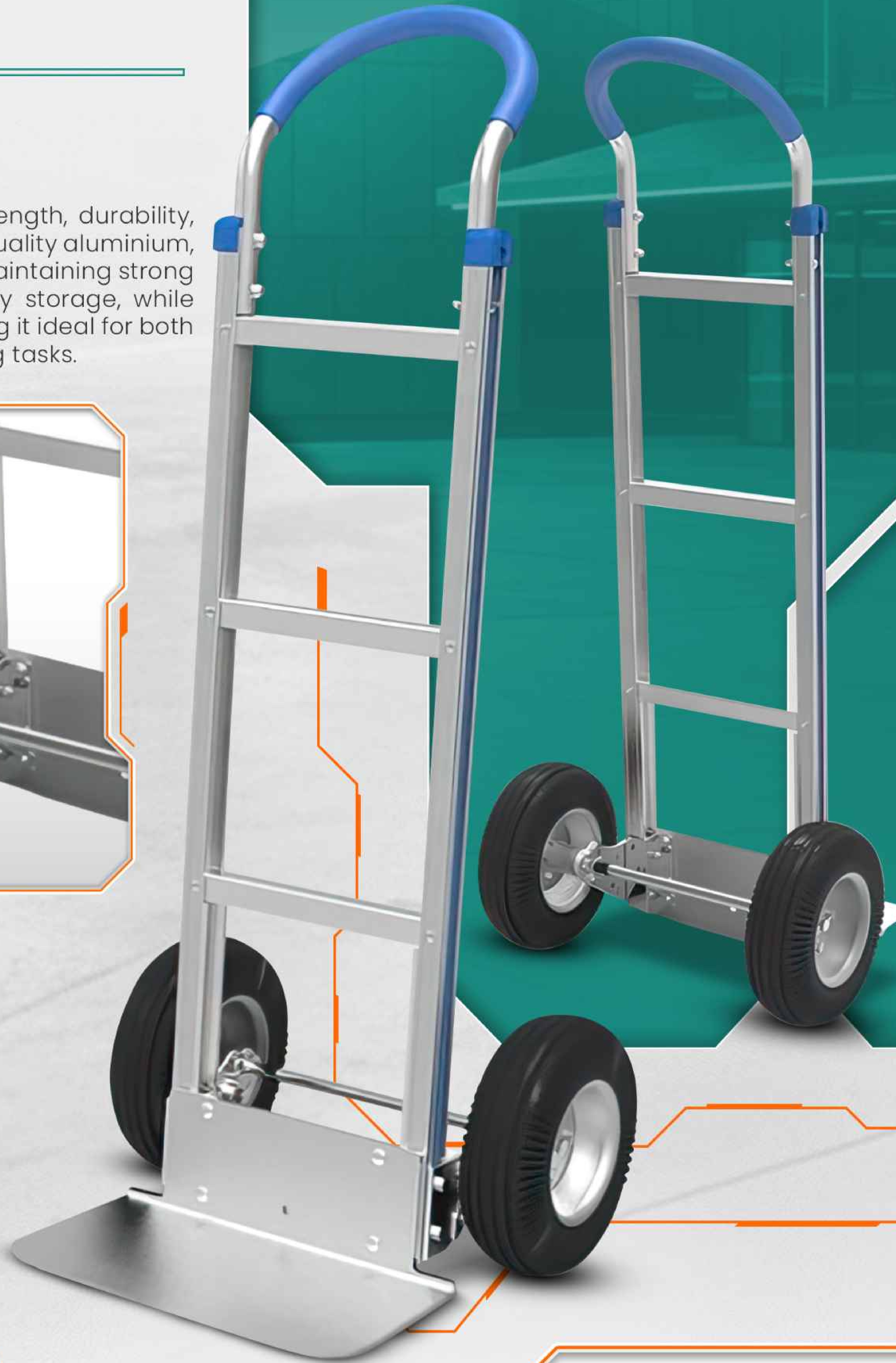

### SPECIFICATION

ITEM NO.	HAHT-82C
NET WEIGHT	10.6 kg
OVERALL SIZE	501 x 506 x 1250 mm
PLATFORM	457.2 x 228.6 x 134 mm
WHEELS	10 Inch
MATERIALS	Alum

# ALUMINUM HAND TROLLEY

## TYPE HAHT-82A

The Aluminium Hand Trolley is designed for strength, durability, and lightweight performance. Made from high-quality aluminium, it offers excellent resistance to corrosion while maintaining strong load capacity. Its foldable design ensures easy storage, while smooth wheels provide effortless mobility, making it ideal for both professional use and everyday material handling tasks.



EASY FOLDING DESIGN



STRONG LOAD CAPACITY



DURABLE MATERIAL BUILD



COMPACT STORAGE SIZE

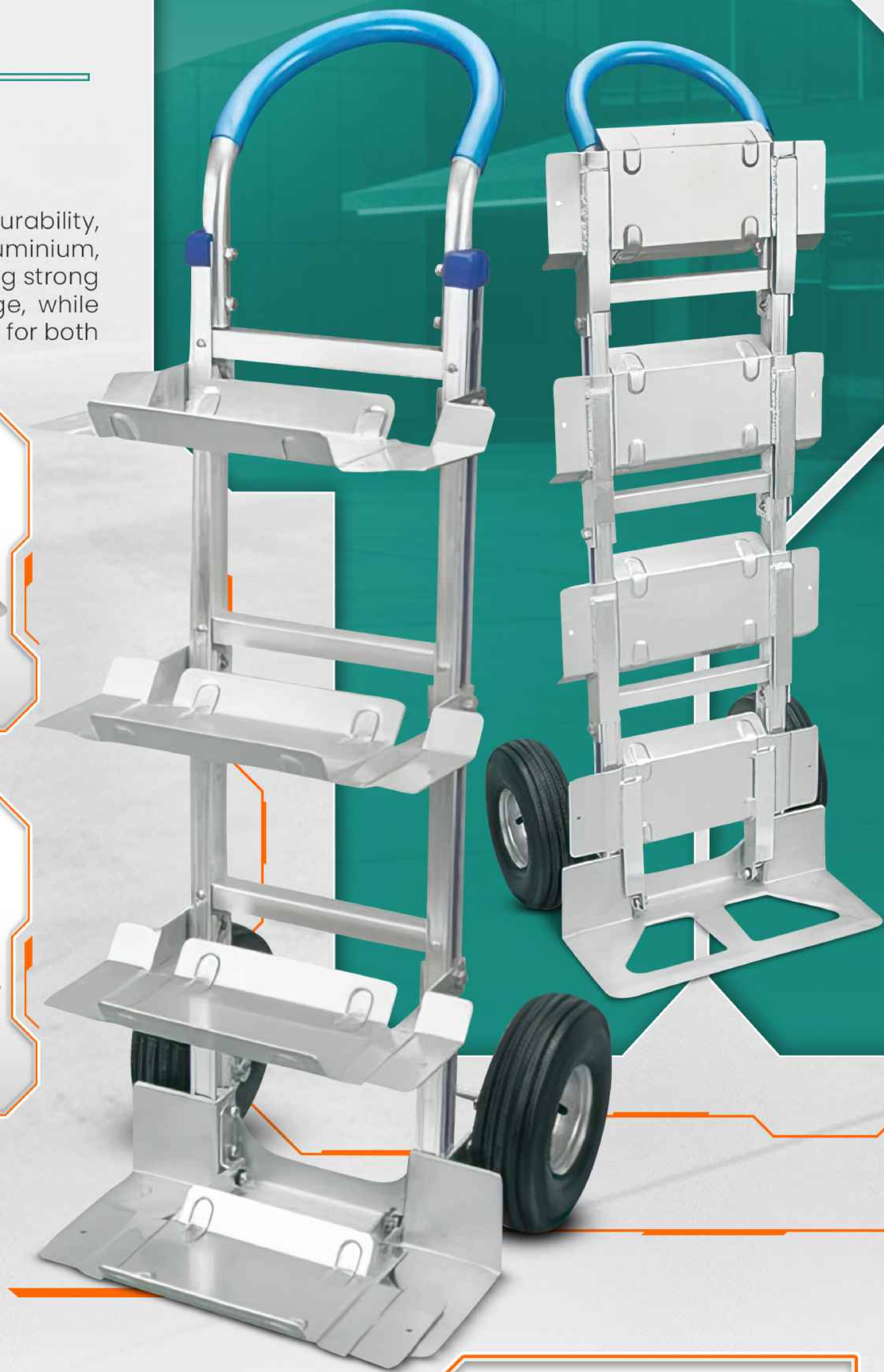

### SPECIFICATION

ITEM NO.	HAHT-82A
NET WEIGHT	10.3 kg
OVERALL SIZE	608 x 506 x 1357 mm
PLATFORM	457 x 232 x 118.5 mm
WHEELS	10 Inch
MATERIALS	Alum

# ALUMINUM HAND TROLLEY

## TYPE HAHT-82NB

The Aluminium Hand Trolley is designed for strength, durability, and lightweight performance. Made from high-quality aluminium, it offers excellent resistance to corrosion while maintaining strong load capacity. Its foldable design ensures easy storage, while smooth wheels provide effortless mobility, making it ideal for both professional use and everyday material handling tasks.



EASY FOLDING DESIGN



STRONG LOAD CAPACITY



DURABLE MATERIAL BUILD



COMPACT STORAGE SIZE



## SPECIFICATION

ITEM NO.	HAHT-82NB
NET WEIGHT	19 kg
OVERALL SIZE	740 x 506 x 1525 mm
PLATFORM	457 x 304.8 x 146 mm
WHEELS	10 Inch
MATERIALS	Alum

# ALUMINUM HAND TROLLEY

TYPE HAHT-82NB

## USAGE



## TURNING FUNCTION



**TURNING FUNCTION**  
Flexible and convenient for various loading needs.

# ALUMINUM HAND TROLLEY

## TYPE HAHT-83

The Aluminium Hand Trolley is designed for strength, durability, and lightweight performance. Made from high-quality aluminium, it offers excellent resistance to corrosion while maintaining strong load capacity. Its foldable design ensures easy storage, while smooth wheels provide effortless mobility, making it ideal for both professional use and everyday material handling tasks.



EASY FOLDING DESIGN



STRONG LOAD CAPACITY



DURABLE MATERIAL BUILD



COMPACT STORAGE SIZE



## SPECIFICATION

ITEM NO.	HAHT-83
NET WEIGHT	9.6 kg
OVERALL SIZE	467 x 506 x 1334 mm
PLATFORM	355.6 x 232 x 118.5 mm
WHEELS	10 Inch
MATERIALS	Alum

# ALUMINUM HAND TROLLEY

## TYPE HAHT-83A

The Aluminium Hand Trolley is designed for strength, durability, and lightweight performance. Made from high-quality aluminium, it offers excellent resistance to corrosion while maintaining strong load capacity. Its foldable design ensures easy storage, while smooth wheels provide effortless mobility, making it ideal for both professional use and everyday material handling tasks.



EASY FOLDING DESIGN



STRONG LOAD CAPACITY



DURABLE MATERIAL BUILD



COMPACT STORAGE SIZE



### SPECIFICATION

ITEM NO.	HAHT-83A
NET WEIGHT	10.1 kg
OVERALL SIZE	467 x 506 x 1530 mm
PLATFORM	355.6 x 232 x 118.5 mm
WHEELS	10 Inch
MATERIALS	Alum

# ALUMINUM HAND TROLLEY

## TYPE HAHT-83B

The Aluminium Hand Trolley is designed for strength, durability, and lightweight performance. Made from high-quality aluminium, it offers excellent resistance to corrosion while maintaining strong load capacity. Its foldable design ensures easy storage, while smooth wheels provide effortless mobility, making it ideal for both professional use and everyday material handling tasks.



EASY FOLDING DESIGN



STRONG LOAD CAPACITY



DURABLE MATERIAL BUILD



COMPACT STORAGE SIZE



## SPECIFICATION

ITEM NO.	HAHT-83B
NET WEIGHT	10 kg
OVERALL SIZE	467 x 506 x 1405 mm
PLATFORM	355.6 x 232 x 118.5 mm
WHEELS	10 Inch
MATERIALS	Alum

# ALUMINUM HAND TROLLEY

## TYPE HAHT-83C

The Aluminium Hand Trolley is designed for strength, durability, and lightweight performance. Made from high-quality aluminium, it offers excellent resistance to corrosion while maintaining strong load capacity. Its foldable design ensures easy storage, while smooth wheels provide effortless mobility, making it ideal for both professional use and everyday material handling tasks.



EASY FOLDING DESIGN



STRONG LOAD CAPACITY



DURABLE MATERIAL BUILD



COMPACT STORAGE SIZE

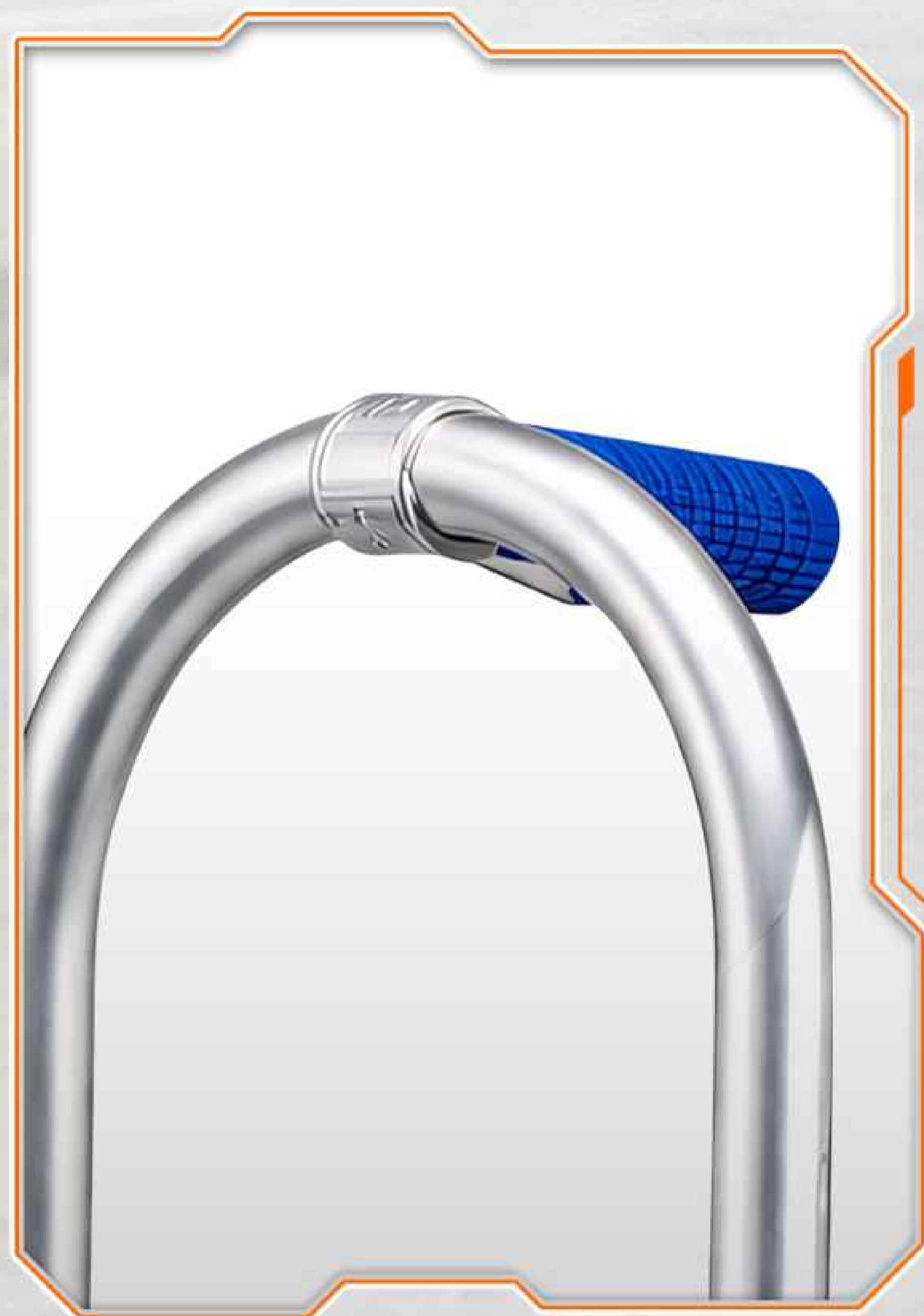

### SPECIFICATION

ITEM NO.	HAHT-83C
NET WEIGHT	9.4 kg
OVERALL SIZE	467 x 506 x 1330 mm
PLATFORM	355.6 x 232 x 118.5 mm
WHEELS	10 Inch
MATERIALS	Alum

# ALUMINUM HAND TROLLEY

## TYPE HAHT-83D

The Aluminium Hand Trolley is designed for strength, durability, and lightweight performance. Made from high-quality aluminium, it offers excellent resistance to corrosion while maintaining strong load capacity. Its foldable design ensures easy storage, while smooth wheels provide effortless mobility, making it ideal for both professional use and everyday material handling tasks.



EASY FOLDING DESIGN



STRONG LOAD CAPACITY



DURABLE MATERIAL BUILD



COMPACT STORAGE SIZE



### SPECIFICATION

ITEM NO.	HAHT-83D
NET WEIGHT	9.8 kg
OVERALL SIZE	467 x 506 x 1390 mm
PLATFORM	355.6 x 232 x 118.5 mm
WHEELS	10 Inch
MATERIALS	Alum

# ALUMINUM HAND TROLLEY

## TYPE HAHT-83E

The Aluminium Hand Trolley is designed for strength, durability, and lightweight performance. Made from high-quality aluminium, it offers excellent resistance to corrosion while maintaining strong load capacity. Its foldable design ensures easy storage, while smooth wheels provide effortless mobility, making it ideal for both professional use and everyday material handling tasks.



EASY FOLDING DESIGN



STRONG LOAD CAPACITY



DURABLE MATERIAL BUILD



COMPACT STORAGE SIZE

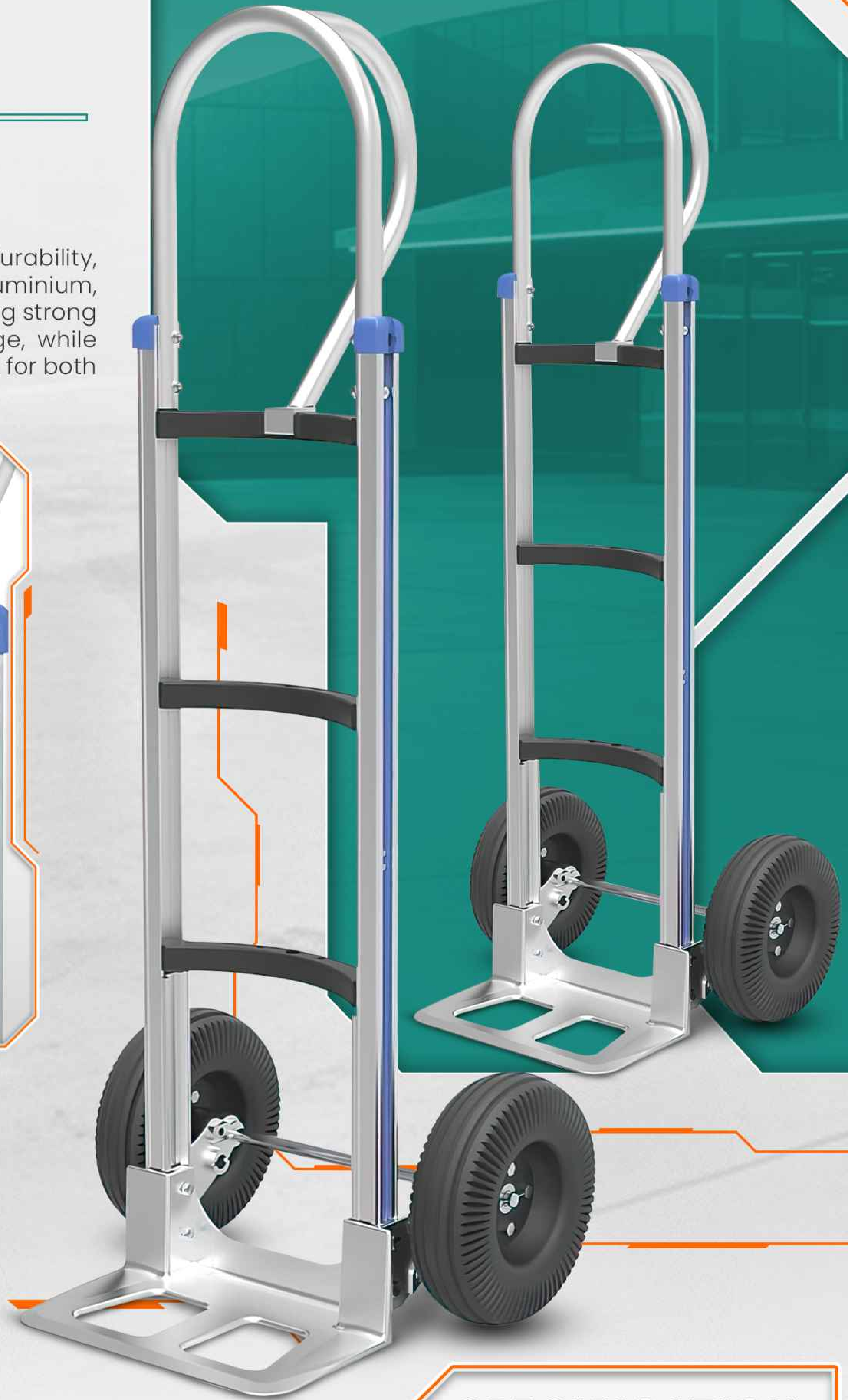

### SPECIFICATION

ITEM NO.	HAHT-83E
NET WEIGHT	10 kg
OVERALL SIZE	467 x 506 x 1334 mm
PLATFORM	355.6 x 232 x 118.5 mm
WHEELS	10 Inch
MATERIALS	Alum

# ALUMINUM HAND TROLLEY

## TYPE HAHT-84

The Aluminium Hand Trolley is designed for strength, durability, and lightweight performance. Made from high-quality aluminium, it offers excellent resistance to corrosion while maintaining strong load capacity. Its foldable design ensures easy storage, while smooth wheels provide effortless mobility, making it ideal for both professional use and everyday material handling tasks.



EASY FOLDING DESIGN



STRONG LOAD CAPACITY



DURABLE MATERIAL BUILD



COMPACT STORAGE SIZE



### SPECIFICATION

ITEM NO.	HAHT-84
NET WEIGHT	10 kg
OVERALL SIZE	467 x 506 x 1232 mm
PLATFORM	355.6 x 232 x 118.5 mm
WHEELS	10 Inch
MATERIALS	Alum

# ALUMINUM HAND TROLLEY

## TYPE HAHT-84E

The Aluminium Hand Trolley is designed for strength, durability, and lightweight performance. Made from high-quality aluminium, it offers excellent resistance to corrosion while maintaining strong load capacity. Its foldable design ensures easy storage, while smooth wheels provide effortless mobility, making it ideal for both professional use and everyday material handling tasks.



EASY FOLDING DESIGN



STRONG LOAD CAPACITY



DURABLE MATERIAL BUILD



COMPACT STORAGE SIZE



## SPECIFICATION

ITEM NO.	HAHT-84E
NET WEIGHT	12.8 kg
OVERALL SIZE	501 x 506 x 1231 mm
PLATFORM	457.2 x 228.6 x 134 mm
WHEELS	10 Inch
MATERIALS	Alum

# ALUMINUM HAND TROLLEY

## TYPE HAHT-84A

The Aluminium Hand Trolley is designed for strength, durability, and lightweight performance. Made from high-quality aluminium, it offers excellent resistance to corrosion while maintaining strong load capacity. Its foldable design ensures easy storage, while smooth wheels provide effortless mobility, making it ideal for both professional use and everyday material handling tasks.



EASY FOLDING DESIGN



STRONG LOAD CAPACITY



DURABLE MATERIAL BUILD



COMPACT STORAGE SIZE

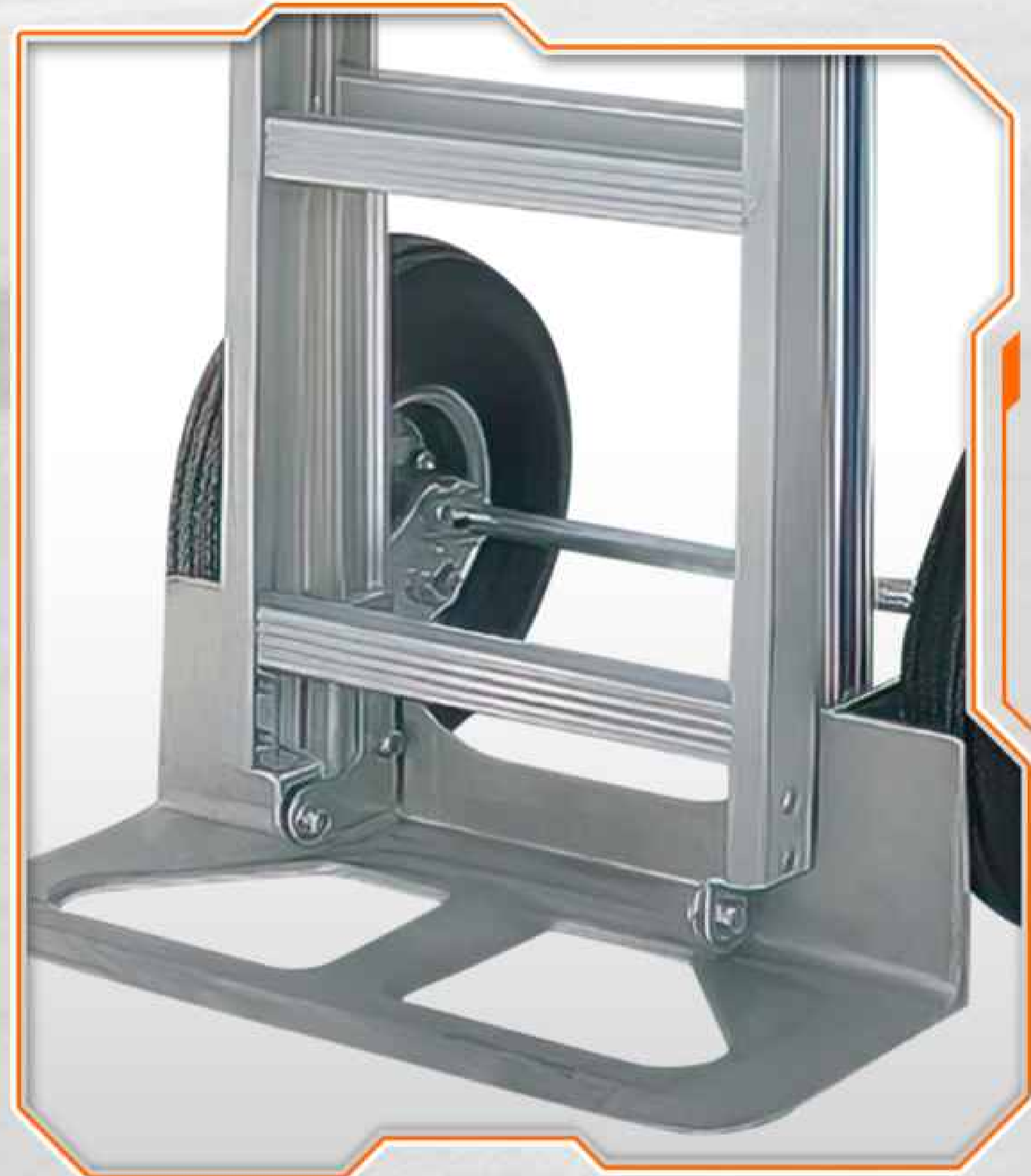

## SPECIFICATION

ITEM NO.	HAHT-84A
NET WEIGHT	11.2 kg
OVERALL SIZE	802 x 506 x 1231 mm
PLATFORM	355.6 x 232 x 118.5 mm
WHEELS	10 Inch
MATERIALS	Alum

# ALUMINUM HAND TROLLEY

## TYPE HAHT-84B

The Aluminium Hand Trolley is designed for strength, durability, and lightweight performance. Made from high-quality aluminium, it offers excellent resistance to corrosion while maintaining strong load capacity. Its foldable design ensures easy storage, while smooth wheels provide effortless mobility, making it ideal for both professional use and everyday material handling tasks.



EASY FOLDING DESIGN



STRONG LOAD CAPACITY



DURABLE MATERIAL BUILD



COMPACT STORAGE SIZE

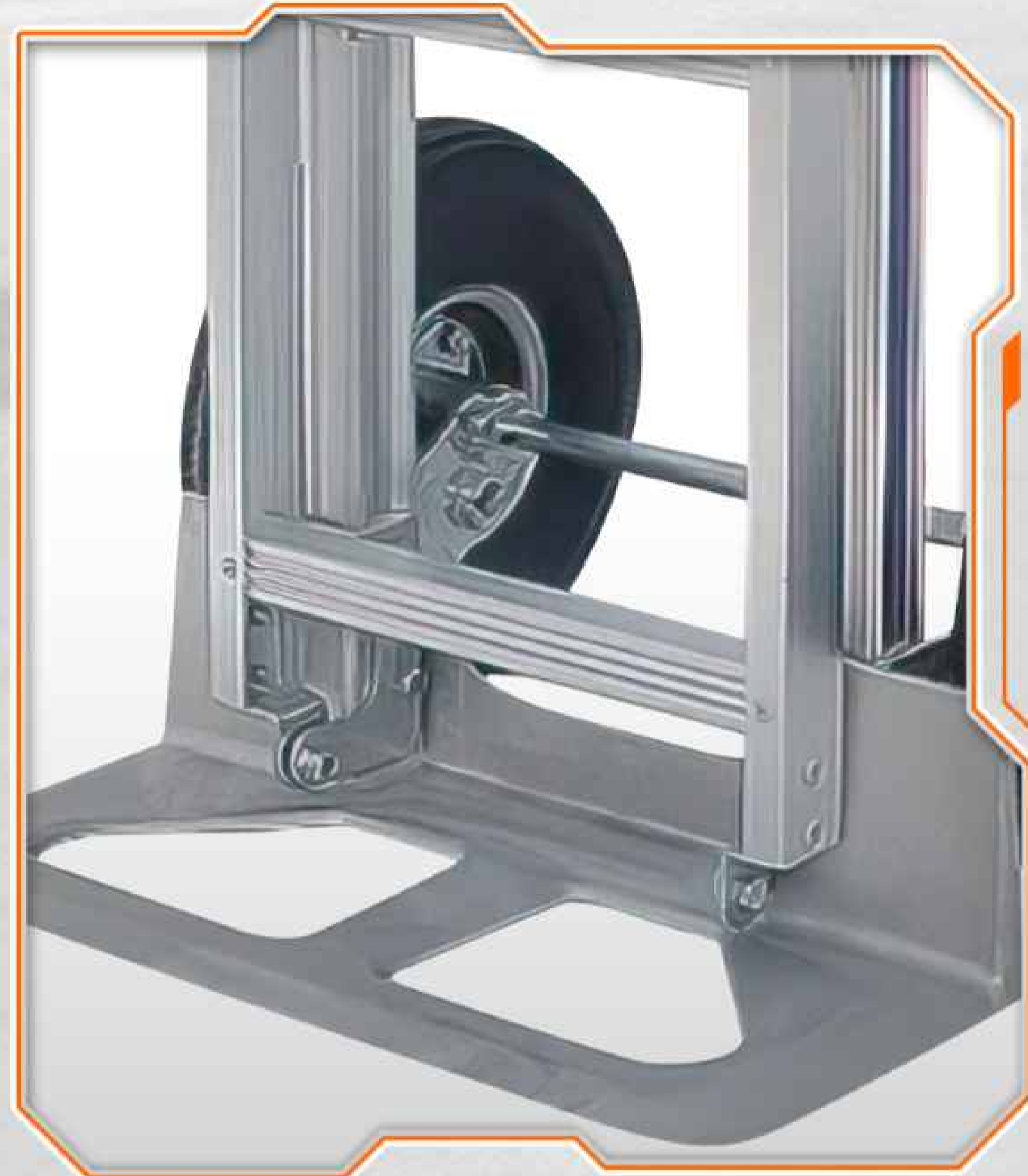

## SPECIFICATION

ITEM NO.	HAHT-84B
NET WEIGHT	11.8 kg
OVERALL SIZE	1057 x 506 x 1232 mm
PLATFORM	355.6 x 232 x 118.5 mm
WHEELS	10 Inch
MATERIALS	Alum

# ALUMINUM HAND TROLLEY

## TYPE HAHT-806

The Aluminium Hand Trolley is designed for strength, durability, and lightweight performance. Made from high-quality aluminium, it offers excellent resistance to corrosion while maintaining strong load capacity. Its foldable design ensures easy storage, while smooth wheels provide effortless mobility, making it ideal for both professional use and everyday material handling tasks.



EASY FOLDING DESIGN



STRONG LOAD CAPACITY



DURABLE MATERIAL BUILD



COMPACT STORAGE SIZE



### SPECIFICATION

ITEM NO.	HAHT-806
NET WEIGHT	19 kg
OVERALL SIZE	695 x 459 x 1596 mm
PLATFORM	457 x 305 x 146 mm
WHEELS	7 Inch
MATERIALS	Alum

# ALUMINUM HAND TROLLEY

## TYPE HAHT-84F

The Aluminium Hand Trolley is designed for strength, durability, and lightweight performance. Made from high-quality aluminium, it offers excellent resistance to corrosion while maintaining strong load capacity. Its foldable design ensures easy storage, while smooth wheels provide effortless mobility, making it ideal for both professional use and everyday material handling tasks.



EASY FOLDING DESIGN



STRONG LOAD CAPACITY



DURABLE MATERIAL BUILD



COMPACT STORAGE SIZE



## SPECIFICATION

ITEM NO.	HAHT-84F
NET WEIGHT	10.5 kg
OVERALL SIZE	467 x 506 x 1231 mm
PLATFORM	457 x 232 x 118.5 mm
WHEELS	10 Inch
MATERIALS	Alum

# ALUMINUM HAND TROLLEY

## TYPE HAHT-88A

The Aluminium Hand Trolley is designed for strength, durability, and lightweight performance. Made from high-quality aluminium, it offers excellent resistance to corrosion while maintaining strong load capacity. Its foldable design ensures easy storage, while smooth wheels provide effortless mobility, making it ideal for both professional use and everyday material handling tasks.



EASY FOLDING DESIGN



STRONG LOAD CAPACITY



DURABLE MATERIAL BUILD



COMPACT STORAGE SIZE



### SPECIFICATION

ITEM NO.	HAHT-88A
NET WEIGHT	13 kg
OVERALL SIZE	801 x 506 x 1231 mm
PLATFORM	457 x 232 x 118.5 mm
WHEELS	10 Inch
MATERIALS	Alum

# ALUMINUM HAND TROLLEY

## TYPE HAHT-88F

The Aluminium Hand Trolley is designed for strength, durability, and lightweight performance. Made from high-quality aluminium, it offers excellent resistance to corrosion while maintaining strong load capacity. Its foldable design ensures easy storage, while smooth wheels provide effortless mobility, making it ideal for both professional use and everyday material handling tasks.



EASY FOLDING DESIGN



STRONG LOAD CAPACITY



DURABLE MATERIAL BUILD



COMPACT STORAGE SIZE



### SPECIFICATION

ITEM NO.	HAHT-88F
NET WEIGHT	12.6 kg
OVERALL SIZE	452 x 506 x 1318 mm
PLATFORM	457 x 228 x 120 mm
WHEELS	10 Inch
MATERIALS	Alum

# ALUMINUM HAND TROLLEY

## TYPE HLC-70B

The Aluminium Hand Trolley is designed for strength, durability, and lightweight performance. Made from high-quality aluminium, it offers excellent resistance to corrosion while maintaining strong load capacity. Its foldable design ensures easy storage, while smooth wheels provide effortless mobility, making it ideal for both professional use and everyday material handling tasks.



EASY FOLDING DESIGN



STRONG LOAD CAPACITY



DURABLE MATERIAL BUILD



COMPACT STORAGE SIZE



## SPECIFICATION

ITEM NO.	HLC-70B		
CAPACITY	60 kg as hand truck 120 kg as ladder	FOLDABLE SIZE	360 x 75 x 1262 mm
NET WEIGHT	6.3 kg	PLATFORM	280 x 225 mm
LADDER SIZE	360 x 740 x 1180 mm	WHEELS	4 Inch
HAN TRUCK SIZE	360 x 450 x 1262 mm	MATERIALS	Alum, PP, TPR, Iron

# ALUMINUM HAND TROLLEY

## TYPE HLC-71

The Aluminium Hand Trolley is designed for strength, durability, and lightweight performance. Made from high-quality aluminium, it offers excellent resistance to corrosion while maintaining strong load capacity. Its foldable design ensures easy storage, while smooth wheels provide effortless mobility, making it ideal for both professional use and everyday material handling tasks.



EASY FOLDING DESIGN



STRONG LOAD CAPACITY



DURABLE MATERIAL BUILD



COMPACT STORAGE SIZE



## SPECIFICATION

ITEM NO.	HLC-71		
<b>CAPACITY</b>	60 kg as hand truck 120 kg as ladder	<b>FOLDABLE SIZE</b>	470 x 75 x 1260 mm
<b>NET WEIGHT</b>	8.3 kg	<b>PLATFORM</b>	380 x 210 mm
<b>LADDER SIZE</b>	709 x 470 x 1180 mm	<b>WHEELS</b>	4 Inch
<b>HAN TRUCK SIZE</b>	470 x 450 x 1262 mm	<b>MATERIALS</b>	Alum, PP, TPR, Iron

# ALUMINUM HAND TROLLEY

## TYPE HLC-72

The Aluminium Hand Trolley is designed for strength, durability, and lightweight performance. Made from high-quality aluminium, it offers excellent resistance to corrosion while maintaining strong load capacity. Its foldable design ensures easy storage, while smooth wheels provide effortless mobility, making it ideal for both professional use and everyday material handling tasks.



EASY FOLDING DESIGN



STRONG LOAD CAPACITY



DURABLE MATERIAL BUILD



COMPACT STORAGE SIZE



## SPECIFICATION

ITEM NO.	HLC-72		
<b>CAPACITY</b>	60 kg as hand truck 120 kg as ladder	<b>FOLDABLE SIZE</b>	335 x 75 x 990 mm
<b>NET WEIGHT</b>	6.5 kg	<b>PLATFORM</b>	380 x 210 mm
<b>LADDER SIZE</b>	530 x 470 x 935 mm	<b>WHEELS</b>	4 Inch
<b>HAN TRUCK SIZE</b>	470 x 72 x 1260 mm	<b>MATERIALS</b>	Alum, PP, TPR, Iron

# HARDWARE ACCESSORIES

HEA0



9"x14" Aluminium Plate

HEA1



9"x18" Aluminium Plate

HEA2



9"x18" Aluminium Plate

HEA3

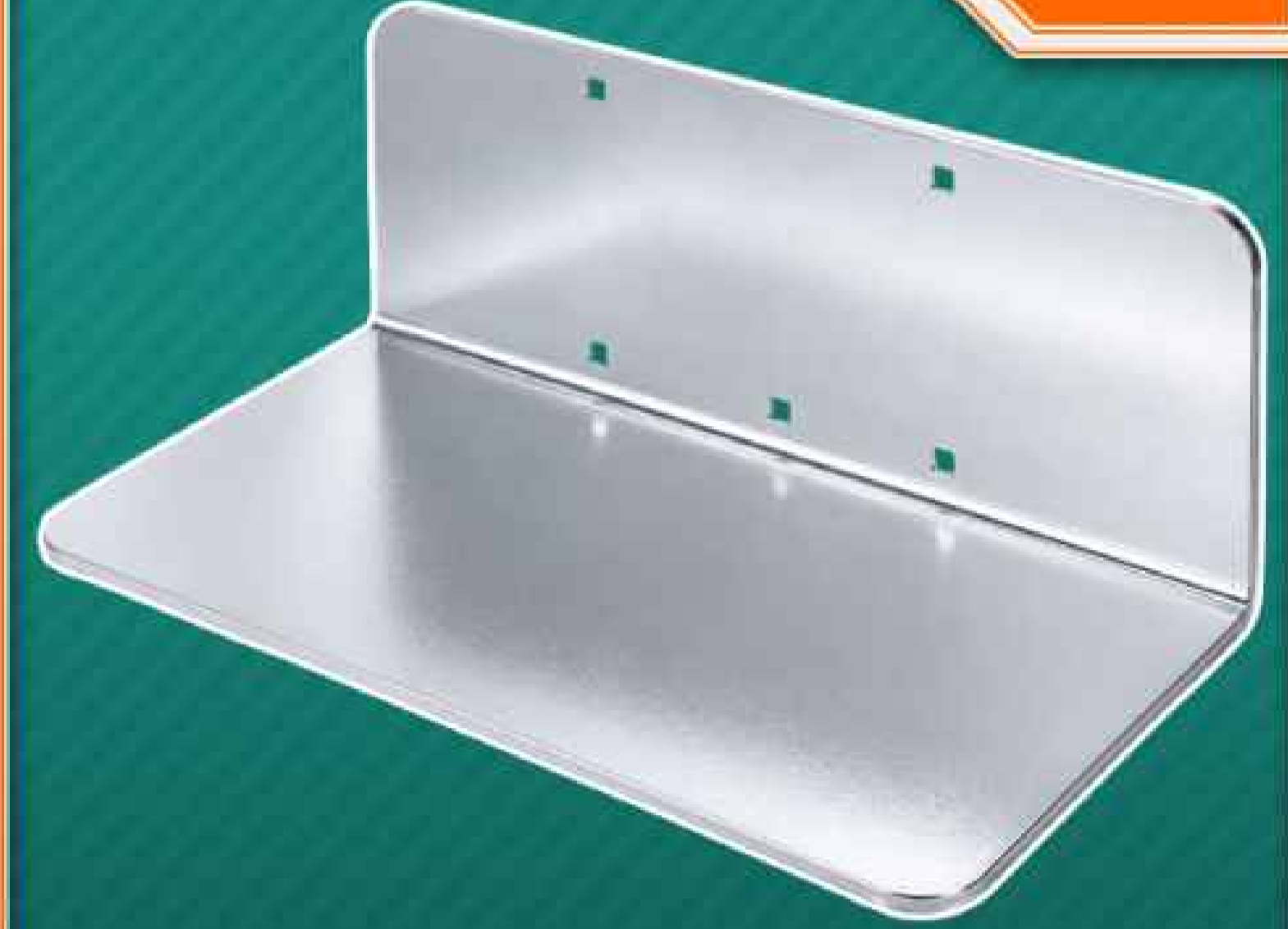

9"x14" Aluminium Plate

HEA4



9"x14" Aluminium Plate

HEA5



12"x16" Aluminium Plate

HPT304

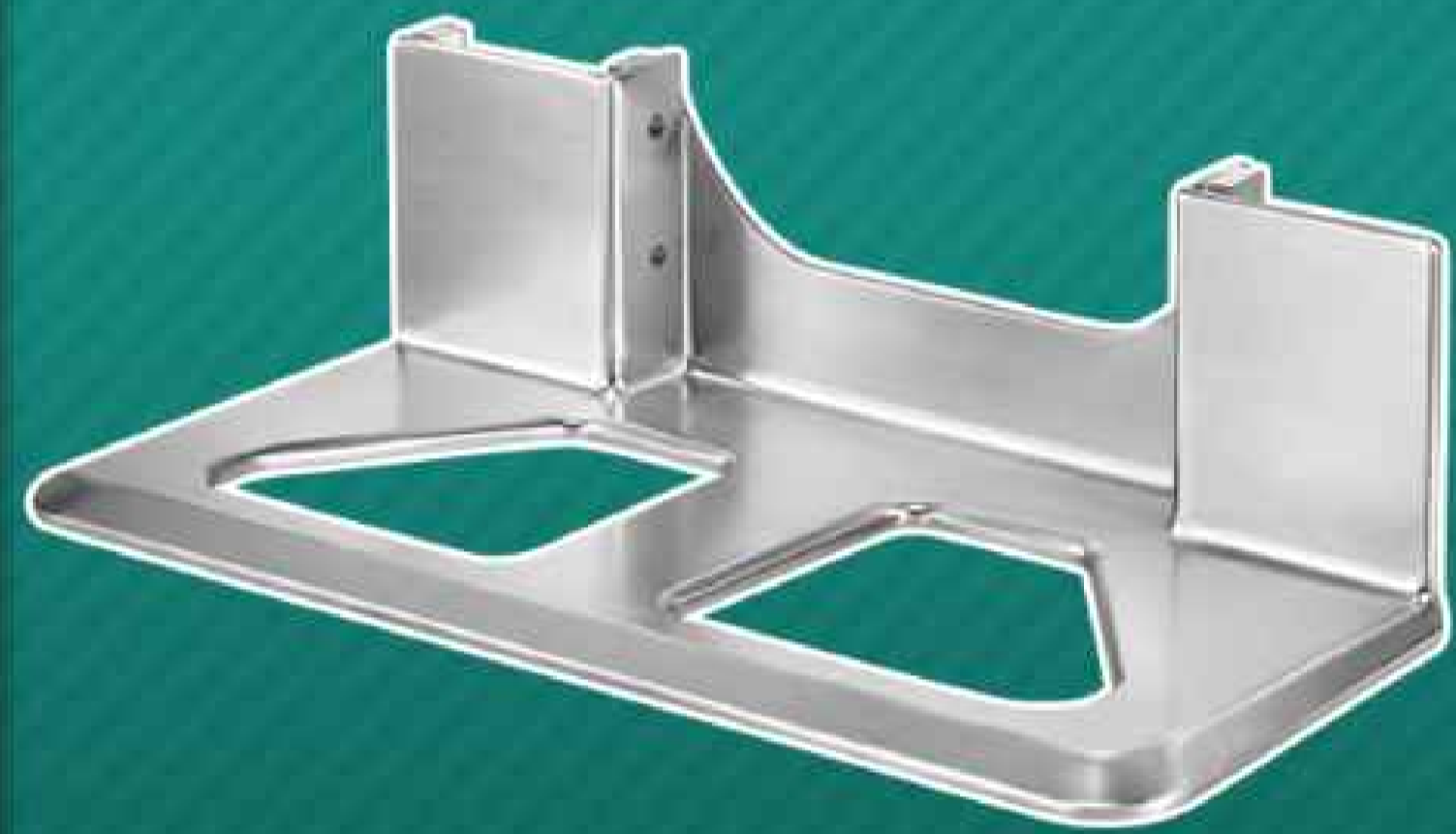

7.4"x14" Cast-Aluminium Plate

HPT305

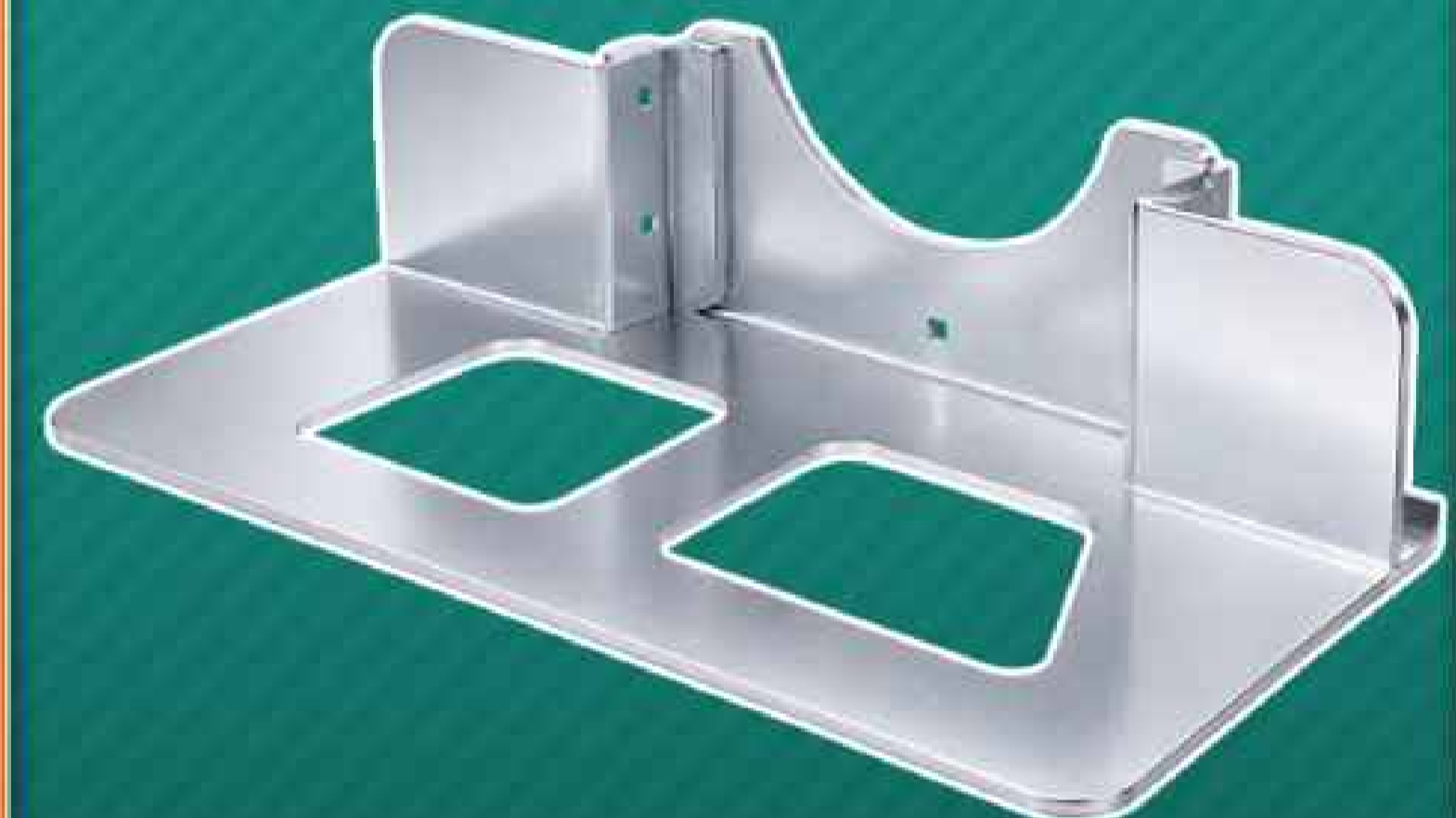

7.4"x18" Cast-Aluminium Plate

HPT308



Aluminium 44x34x3.5 CM

HPT309



Aluminium 33x28x5 CM

HPT801



Two-Ply Aluminium Nose

HPT110



Three-Ply Aluminium Nose

HPT101



Loop Handle

HPT102



D Handle

HPT103

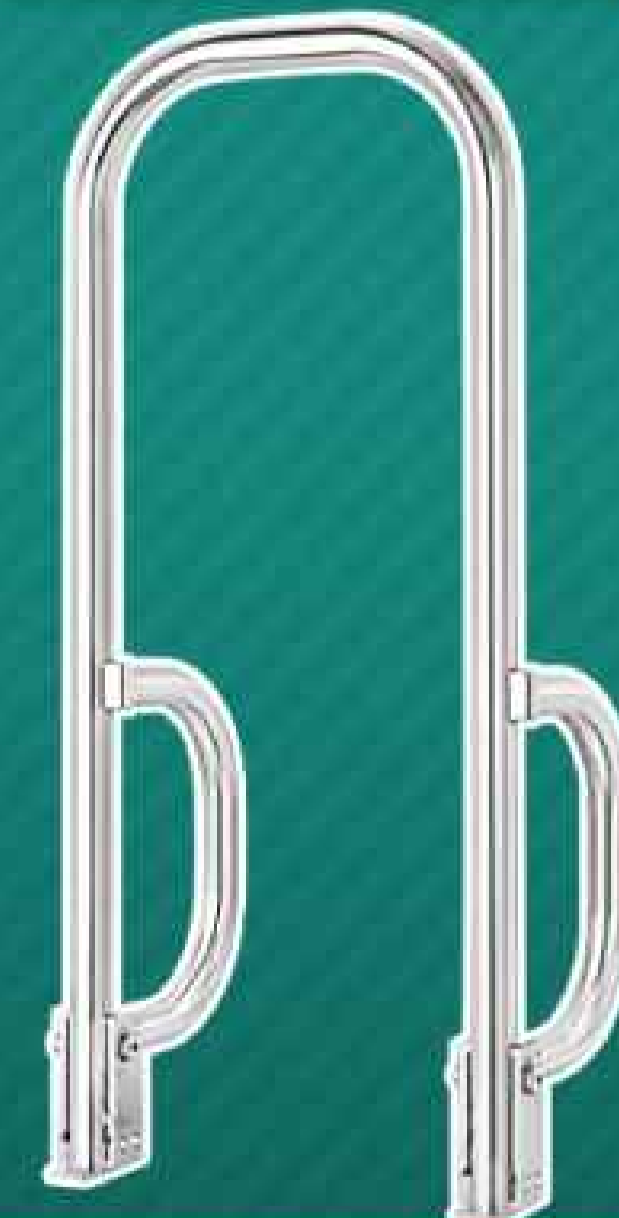

D Tall Handle

HPT104



Pup Handle

# HARDWARE ACCESSORIES

HPT105



PL-Handle

HPT106



Continuous Handle 1

HPT108



Continuous Handle 2

HPT109



Continuous Handle with Vinyl Grip

HPT111

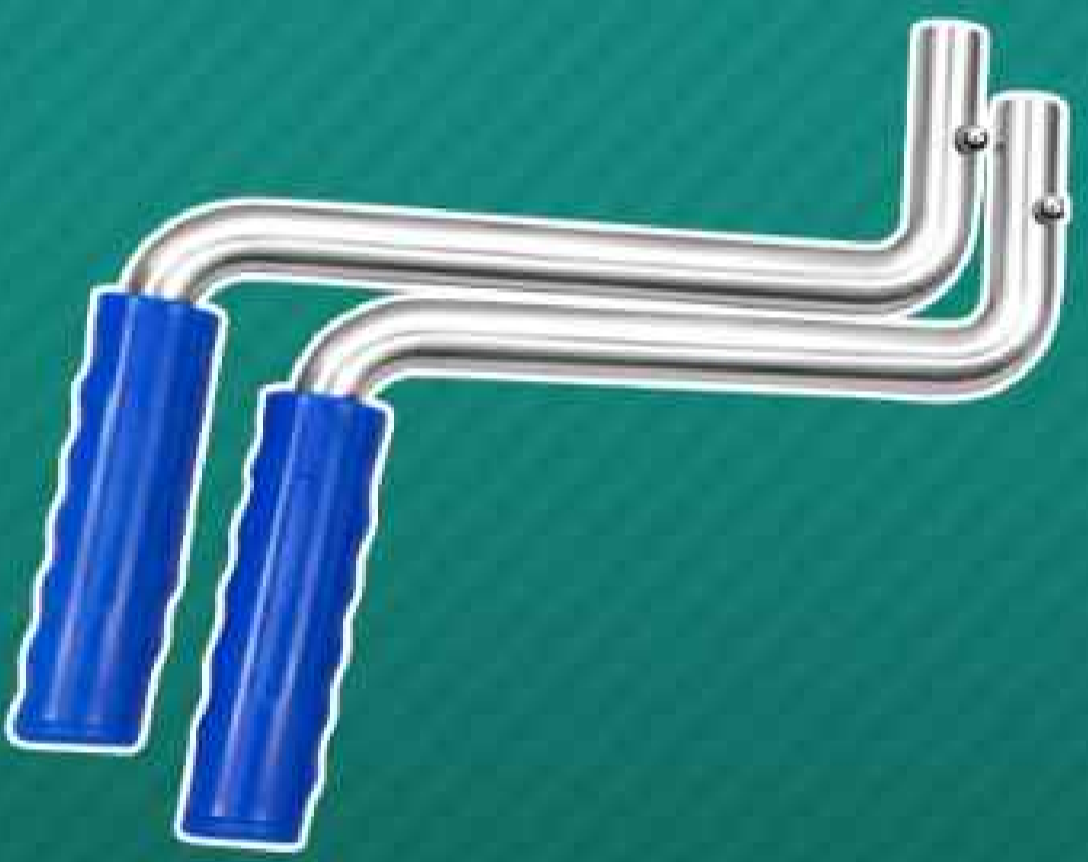

Twin Handle with Hand Grip 1

HPT112



Twin Handle with Hand Grip 2

HPT113



P-P Handle

HPT501



8.5"x18" Handle Extension

HPT502



15.5" Handle Extension

HPT503



17.7" Handle Extension

HPT504



24.2" Handle Extension

HNO1



Straight Plastic Pole (middle frame)

HNO2



Bend Plastic Pole (Middle Frame)

HPT 601



Frame 1

HPT 602



Frame 2

HPT 604



Frame 3

# HARDWARE ACCESSORIES

HPT605



Frame 3

HPT606



Aluminium Ploe Frame (Right and Left)

HPT201



Anti-slip Strip

HPT202



Strengthen Pole

HPT206



Plastic Handle

HPTL101



Axle for Wheel

HPLT102



Plastic Handle

HPLT103



Plastic Handle

HPLT104



Plastic Handle

HPT701



Wheel Bracket

HSEPY001

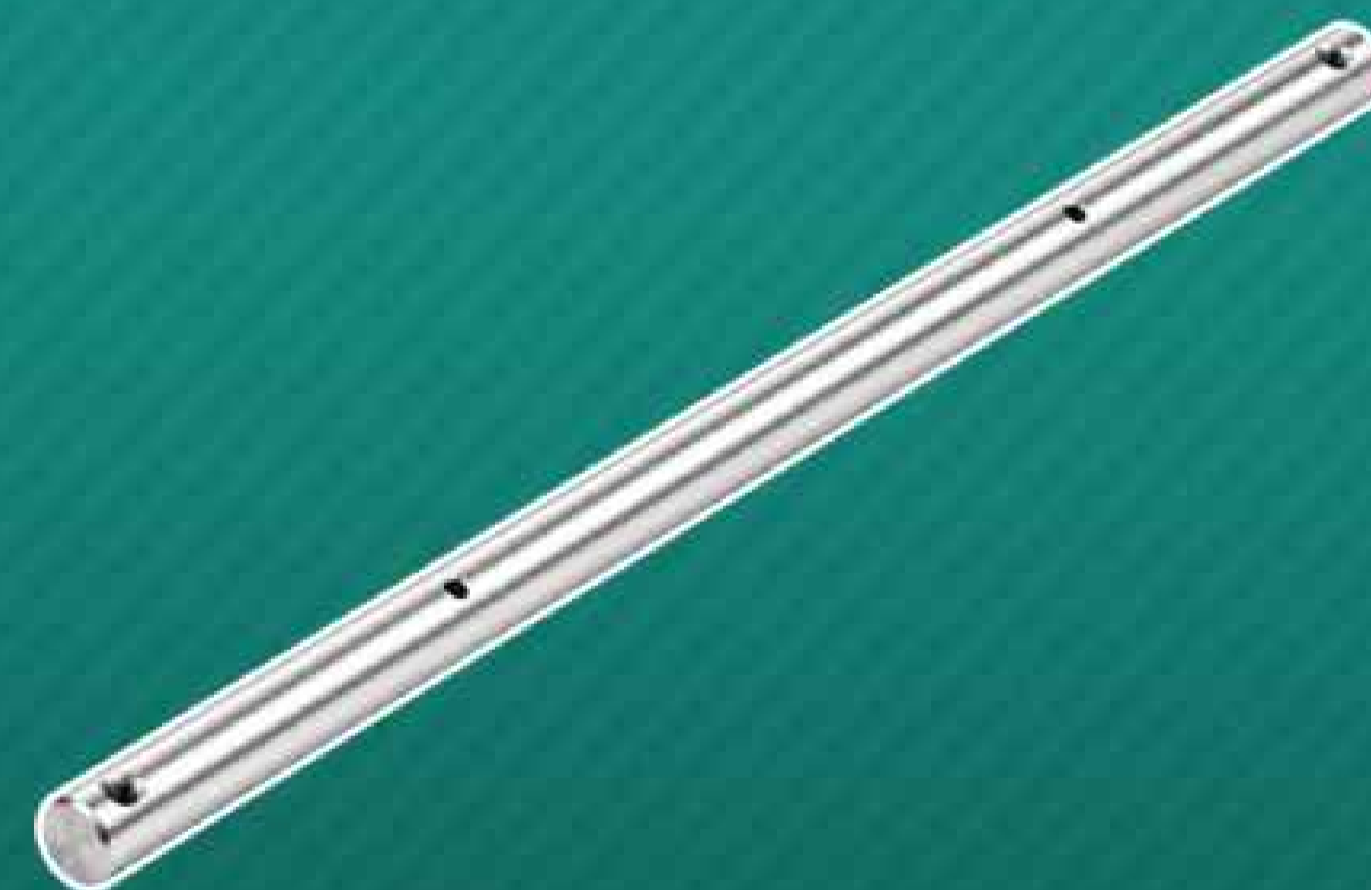

Axle for Wheel

HCR20



Dimension: 3.5"

HCR30



Dimension: 4"

HCR31



Dimension: 4"

HCR32



Dimension: 4"

HCR33



Dimension: 4"

# HARDWARE ACCESSORIES

HCR50



Dimension: 5"

HCR51



Dimension: 5"

HCR52



Dimension: 5"

HCR53



Dimension: 5"

HCR70



Dimension: 5"

HCR73



Dimension: 7"

HCR74



Dimension: 7"

HCR75



Dimension: 7"

HCR81



Dimension: 7"

HCR101



Dimension: 8"

HCR103



Dimension: 10"

HCR106



Dimension: 10"

# INDOTARA®

## PT. INDOTARA PERSADA

### Our Marketing Office and After Sales Service Center

#### Head Office

50/F, Menara BCA Grand Indonesia  
Jl. M.H. Thamrin No.1  
Jakarta Pusat 10310  
021 - 5011 2224  
dsme@indotara.id



#### Semarang Office

Wisma HSBC Lt. 6 suite 609  
Jl. Gajah Mada No.135,  
Semarang, Jawa Tengah - 50134  
024 - 40 300 889  
smg.dsme@indotara.id



#### Marketing Office

Maggiore Business Loft No. 01-02  
Gading Serpong,  
Tangerang - Banten 15332  
021 - 5011 2224  
dsme@indotara.id



#### Medan Office

Sutomo Tower Lantai 5H  
Jl. Sutomo Ujung No.28,  
Kota Medan, Sumatera Utara 20235  
061 - 50 300 592  
mdn.dsme@indotara.id



#### Graha Indotara

Millenium Industrial Estate  
Jl. Millenium 22 Blok R3 No. 1,  
Cikupa, Tangerang - Banten 15720  
021 - 5011 2224  
dsme@indotara.id



#### Makassar Office

Fajar Graha Pena Lt. 5  
Jl. Urip Sumoharjo No. 20,  
Makassar - Sulawesi Selatan 90234  
021 - 5011 2224  
mks.dsme@indotara.id



#### Bandung Office

Wisma HSBC Lt. 6 Suite B  
Jalan Asia Afrika No.116,  
Kota Bandung, Jawa Barat 40112  
021 - 5011 2224  
bdg.dsme@indotara.id



#### Balikpapan Office

Panin Tower Lt. 8 Grand Sudirman  
Jl. Jendral Sudirman No.7 Klandasan Ilir,  
Balikpapan Kota - Kalimantan Timur 76114  
021 - 5011 2224  
bpp.dsme@indotara.id



#### Surabaya Office

Japfa Indoland Center, Tower I Lt. 10/1008  
Jl. Jendral Basuki Rahmat 129-137  
Surabaya 60271  
031 - 3360 1485  
sby.dsme@indotara.id



#### Bali Office

Benoa Square Lt. 2  
Jl. Bypass Ngurah Rai No. 21 A Kedonganan,  
Kuta Badung - Bali Indonesia 80361  
021 - 5011 2224  
bali.dsme@indotara.id



#### Yogyakarta Office

Hartono Mall Yogyakarta Lt. 3  
Kaliwaru, Condongcatur,  
Sleman, Yogyakarta 55281  
021 - 5011 2224  
yog.dsme@indotara.id



#### Singapore Office

Marina Bay Financial Centre Tower 3  
17F, 12 Marina Boulevard  
Singapore - 018982  
021 - 5011 2224  
sing.dsme@indotara.id

